



NEWS SEPTEMBER
2024

Sail in a sea of accessories



Extensive documentation

14,000 downloadable files (interactive 3D models, instructions, certificates and technical specifications)



Excel-compatible

Copy/paste your orders from Excel and export your cart in a click



Replacement Items

Is an item discontinued? We suggest the optimal alternative for your needs



Best price

We always suggest the recommended quantity at the lowest price



Price lists

Check your reserved price list in real time



Your history

Check your order history at all times, online and offline



Online support

Contact our WhatsApp support service for advice and solutions



"Do it yourself" RMA

Select purchased items and compose your return order



Outlet

Discover thousands of items at discounted prices up to 40%

▲ IDENTITY

Osculati is the leading company in Italy and one among the most important companies in Europe in the marine accessory market, a safe and reliable reference point for professionals and pleasure boaters.

The company, founded in 1958 as the first marine accessory retailer in Milan, has turned into an international company and exclusive and official partner of some of the major shipyards in the world.

The third generation of the family, Alberto, Giorgio and Claudia Osculati is proud to support the Chairman Mario Osculati in the management of the company, with the help of the partners Francesco and Alessandro Gambogi.

Osculati's products can be found in thousands of shops and shipyards in 100 countries. The company has developed a professional sales force worldwide, with a turnover of € 112 million in 2023, more than 166 direct employees for a total available area of 21,000 sq.m.



▲ OUR NUMBERS



17,5

tons of goods we deliver every day



100

number of countries regularly supplied with our goods



22.000

products on our Master Catalogue



7.000

Osculati trademark products



166

direct employees



42.000.000 €

value of goods in our stock



96%

goods availability



1.000

new entries in our catalogue every year



21.000 mq

overall storage area



6.000

dealers worldwide

▲ DESIGN & ENGINEERING

The product development process often starts thanks to the innovative addition that has always characterized the Osculati family and the Chairman Mario Osculati in particular.

Inputs and suggestions from our customers, mainly shipyards, as well as from the sailors and boaters that work with us, trigger a process of constant development to create new solutions that fully meet any requirements.

Over 7000 articles developed by the company's Design & Engineering department where a team of engineers and designers is dedicated to the in-house development of CAD models and the implementation of prototypes and samples by means of 3D printers.

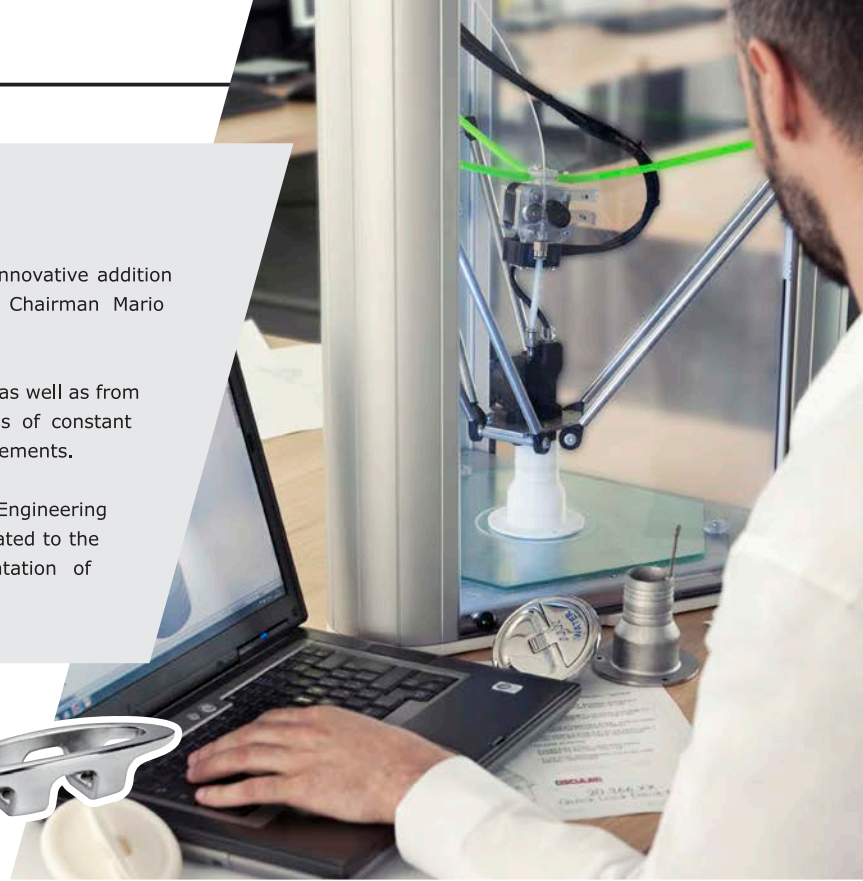

▲ QUALITY CONTROL

Our Integrated Quality Management Team consists of 5 internal inspectors who daily put products through different levels of quality tests according to their market category.

Our salt spray chamber and UV-chamber test both accelerated ageing due to tough marine environment and damage caused by sunlight. Our in-house lab also tests all new products before they are placed on the market in order to offer increasingly higher quality standards.

We work with the best-known labs and institutions to perform accurate IP water-resistance tests, electrical tests as well as breaking loads tests.

- Over 70,000 annual tests
- 50 product certifications every year.
- Over 6,000 hours of salt spray chamber tests per year
- Over 5,000 hours of UV-chamber tests per year



▲ PRODUCTS TAILORED FOR THE SHIPYARDS

Thanks to our new laser printer the items on our catalogue can be tailored by engraving logo and name.

On demand we also make products that meet specific needs in order to develop the best solutions as for design and efficiency:

- Stainless steel items designed ex-novo by the specific needs of the customer.
- Plastic tanks (for freshwater, black water, diesel and petrol) tailored to the boat spaces.
- Hatches in the desired RAL colours.

We also take care of the type testing procedures and the documents needed.



▲ IN-HOUSE PRODUCTION

An in-house production, assembly and packaging department where by 30 specialised workers produce lights, ladders, gangways, battery switches and many other products.

This allows us the highest production process control by an ongoing monitoring of all production steps, production time reduction and flexibility to meet our customers' requirements.

Moreover thanks to a short supply chain we can be more competitive on the market.

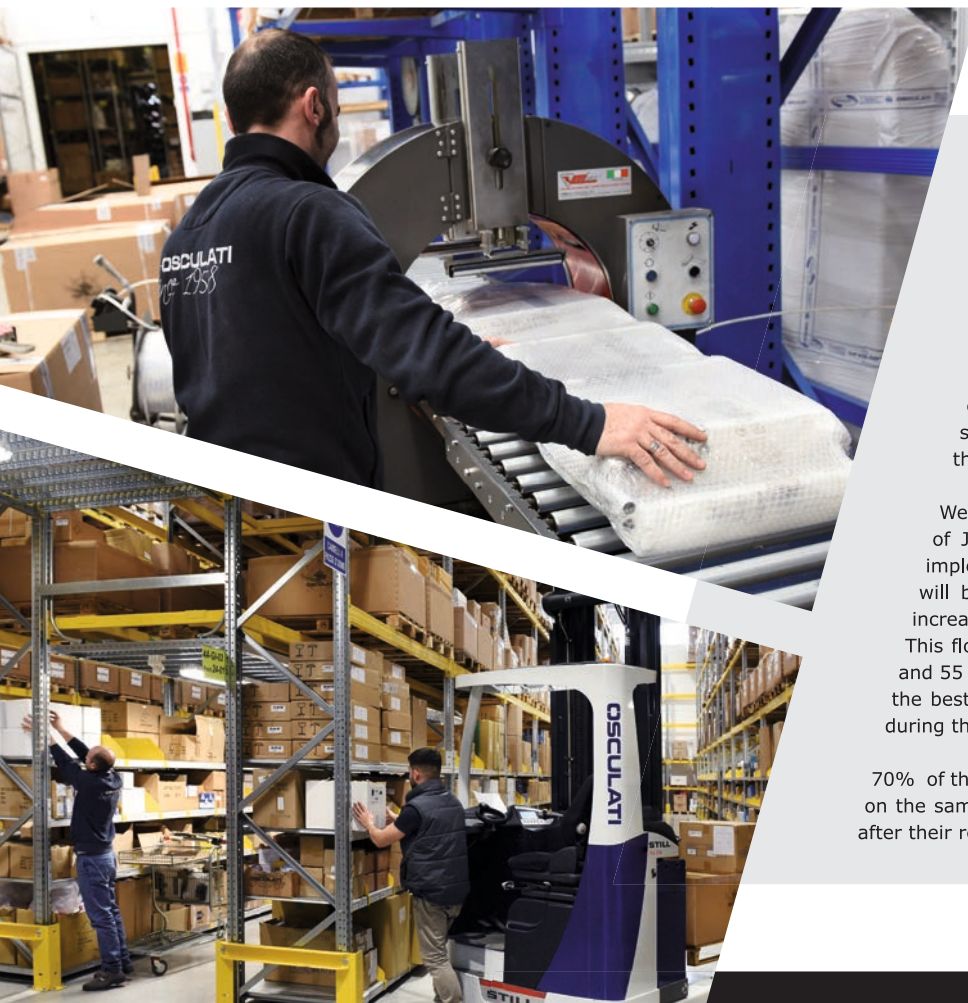

▲ LOGISTICS

Our marine equipment warehouse is the largest in Europe and one of the best-stocked worldwide offering over 22,000 items and goods availability exceeding 96%.

21,000 square metres, 42-million Euros worth goods in our depots, 17,5 tons of marine equipment shipped every day: these are the figures of Osculati's logistics.

We pursue innovation and technological upgrading. As of January 2022, a new semi-automated area will be implemented where over 40% of the orders in progress will be dealt with aimed at offering our customers an increasingly faster and better service.

This flood of items is managed by 75 qualified warehouse and 55 logistics operators staff who work every day to offer the best standards in terms of efficiency, speed and safety during the preparation and shipment of goods to customers.

70% of the orders coming from the European Union is shipped on the same day while the remaining 25% is shipped the day after their reception.



#blueplanet

Osculati x One Ocean Foundation

One Ocean Foundation was established with the aim of accelerating solutions to ocean problems by inspiring international leaders, promoting a sustainable blue economy, and improving ocean literacy. Over the past four years, One Ocean Foundation has collaborated with high-level institutions, research centers, and universities.

Osculati is proud to have supported the research project for the repopulation of Posidonia "Blue Carbon Project", aimed at restoring the Posidonia oceanica meadow in the seabed of the Marine Protected Area of Isola di Bergeggi (Savona) in Liguria, thus contributing to the conservation of our precious marine ecosystem.

Here are some of the project achievements:



Quarterly site monitoring showed an excellent **survival rate of 81% for the transplanted seedlings**, one year after the intervention.



The mats used in the transplant are well anchored, and the seedlings successfully **resisted the strong winter storms**.



In April, we organized the **first educational activity**, involving about 40 students from the Bergeggi elementary school.



The **documentary on the project** was presented at the **Riviera Film Festival** and during **One Ocean Week Milano**, generating great interest.



The **first scientific article** on the Posidonia oceanica reforestation project **has been published**, documenting progress and challenges.

Download our report
here!



Cruiser Shore power

Marine plug and socket for 16A/32A - 230V shore power cord.
Simple and compact design for easy installation in any place of the cockpit
In compliance with the IEC 60309-5 European safety standards.

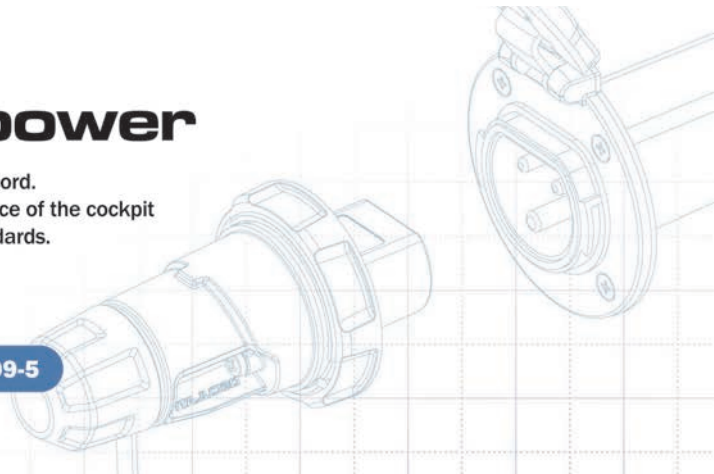

Cruiser 16A socket and plug

16A	IP67	IEC 60309-5
-----	------	-------------

Marine plug and socket for 16A - 230V shore power cord.
Made of PA6, fitted with high energy efficiency contacts and IP67 cover.
Plug designed for ergonomic grip, fastened to the boat socket through a rotating bezel. IP67 watertight closure. A rubber cap ensures IP44 tightness when unplugged.
Simple and compact design for easy installation in any corner of the cockpit
In compliance with the IEC 60309-5 European safety standards.

Code	Model	Lid material	A	V
14.416.01	3P socket	Pa6	16	230
14.416.11	New 3P socket	SS	16	230
14.416.02	3P plug	Pa6	16	230



Cruiser 32A plug and socket

32A	IP67	IEC 60309-5
-----	------	-------------

Nautical socket and plug for 32A - 230V shore power cable. Made of PA6, equipped with high energy efficiency contacts and an IP67 closure cap. The plug is designed to ensure an ergonomic grip, and the rotating ring allows it to be securely fastened to the boat's socket with an IP67 watertight seal, while the rubber cap ensures an IP44 seal when not connected. The clean design and compact dimensions allow for convenient installation of the socket anywhere in the cockpit.
Compliant with European safety standards IEC 60309-5.

Code	Model	material	A	V	IP
14.432.01	3P socket	Pa6	32	230	IP67
14.432.02	3P plug	Pa6	32	230	IP44/IP67

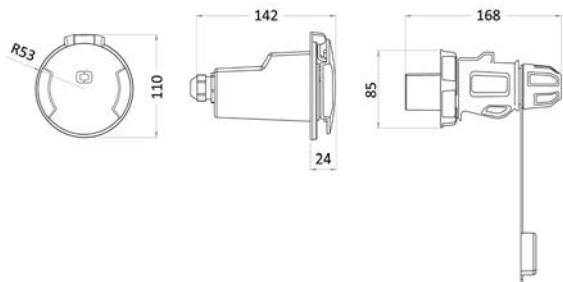

Retractable electric cable

IP44 AISI 316 AUTOMATIC ROLLABLE

Innovative electrical cable dock system. Hull hidden installation.
 Thanks to an automatic retractable dispenser the electrical cable is drawn from a box and directly connected to the dock pillar.
 To stow the cable, just unlock the seal and wait for the retractor to automatically rewind the extracted cable.
 Once the cable is stowed away, the system disappears inside the hull into an elegant mirror-polished stainless steel box that ensures IP44 airtight seal.
 The alignment between the winder and the bush can be oriented in any direction with a maximum recommended angle of 80°.
 Available in two versions with different cable capacities of 16A and 32A.
 Internal winder supplied with adjustable mounting brackets.

Code	Model	A	Cable length m	Cable cross-section mm ²	V	A mm	B mm	C mm
14.322.01	3P plug	16	15	3x2.5	230	220	400	150
14.322.06	3P plug	32	17	3x4	230	220	460	340

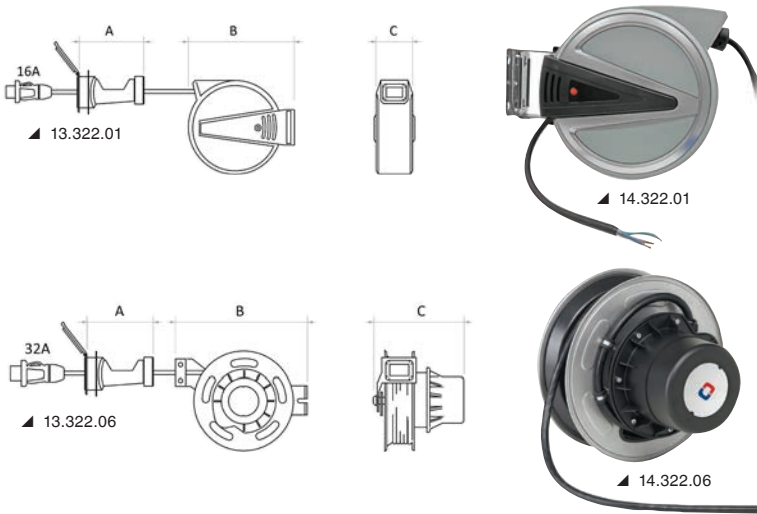

OSCULATI

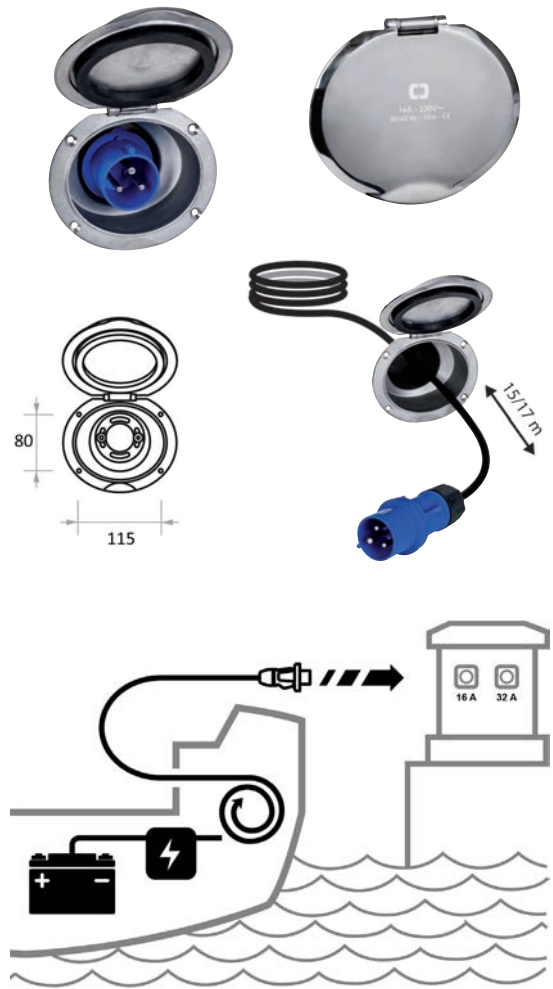

Dock cable with braid and Cruiser plug

16A ROPE FEELING

Electrical cable coated with a special polyester sock that provides wear protection and nautical look.
 Equipped with a 16A Cruiser plug on the boat side and a three-pole industrial plug on the dock side.

Code	Length m	A	Ø outer cable mm	Cable cross-section mm ²	Dockside plug
14.416.60	10	16	12.4	2.5	14.335.01
14.416.61	15	16	12.4	2.5	14.335.01



OSCULATI



Cruiser dock cable and plug

16A IP67 IEC 60309-5

Code	Length m	A	Ø outer cable mm	Cable cross-section mm ²	Dockside plug
14.416.10	10	16	11.2	2.5	no
14.416.15	15	16	11.2	2.5	no
14.416.20	10	16	11.2	2.5	14.335.01 (16A)
14.416.25	15	16	11.2	2.5	14.335.01 (16A)
14.432.10	New	32	14	3x4	no
14.432.15	New	32	14	3x4	no
14.432.20	New	32	14	3x4	14.355.02 (32A)
14.432.25	New	32	14	3x4	14.355.02 (32A)

OSCULATI





Light rod with removable wireless base

WIRELESS

USCG

LED

CARBON

Removable 360° white light rod with 2NM visibility.

It features a special mounting base that allows operation via a wireless contact, prevents exposed metal contacts and ensures completely watertight seal.

The pole is secured at the base with a sturdy bayonet fitting. Once stowed, only a small flat disc with a stainless steel edge is visible on the hull.



Code	Length cm	Light colour	Pole material	LED included
11.152.01	60	Black plastic	Carbon	12V - 2.5W
11.152.02	100	Black plastic	Carbon	12V - 2.5W

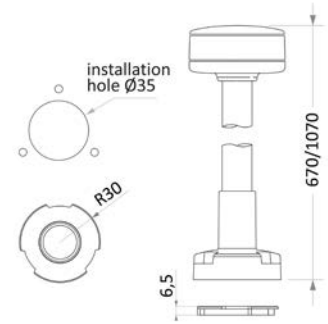

Stainless steel toggle fastener suitable for trunks and hatches

FULLY FLUSH OPEN AND CLOSE

Mirror-polished AISI 316 stainless steel lever closure, designed to fit various applications and ensure the closure of any hatch.

The locking pin with eccentric hole can be rotated to achieve the desired closing tension.

Once installed, the device has a flush design with ergonomic handle for easier use.

When open, the closing hook rotates at 180° and doesn't exceed the handle overall dimensions thus preventing to be hit by mistake.

It includes a PVC template for easier installation.



▲ Fully flush when not in use

Code	←→ mm			Screw size
	A	B	C	
38.213.00	80	26	13	M4
38.213.01	100	32	16	M5

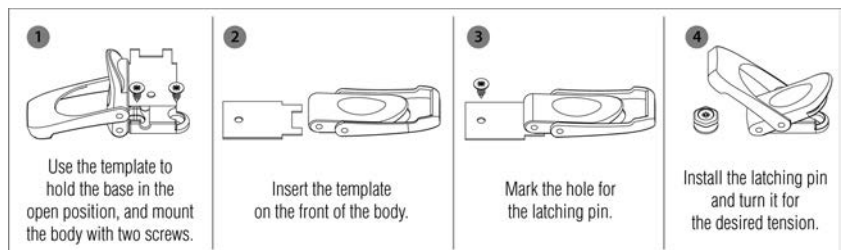
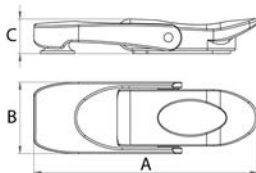

Waterfall skin fitting/drain well for transoms

REGISTERED DESIGN

13° INCLINATION

FAST
INSTALLATION

ISO 9093

This system ensures the following advantages in a single product:

- Easy installation (1 operator only);
- Pre-assembly of the gate valve and hose holder at the workbench (threaded version);
- Locknut for positioning the gate valve in the desired position (threaded version);
- Drainage without unwanted siphon formation thanks to 13° inclination;
- Integrated non-return valve in case of reverse;
- Stainless steel finishing without visible screws.

Assembly sequence:

- Workbench pre-assembly of gate valve and hose holder (option to choose valve handle positioning);
- Insertion of the pre-assembled module from inside (optional pre-fixation with self-tapping screws from inside) - end of internal installation -;
- Screw tightening of the final fixing nut from outside;
- Cutting of the exceeding part;
- Non-return valve plate mounting;
- Stainless steel finish clip mounting;

Code	Thread A	Internal connection B	For thick bulkheads (mm)	Net passage mm
17.397.06	1" ½ GAS	Hose holder 38 mm	10 - 60	Ø 36
17.398.06	1" ½ GAS	Thread 1" 1/2	10 - 60	Ø 36

Made of glass-filled Nylon, ideal for coupling with type 17.233.xx plastic shutters

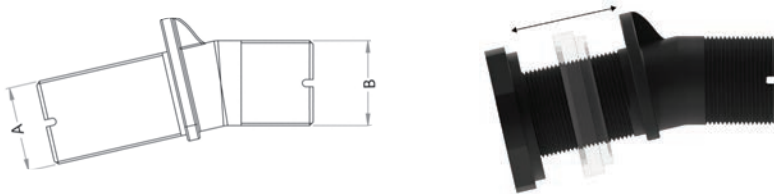

Easy pre-assembling

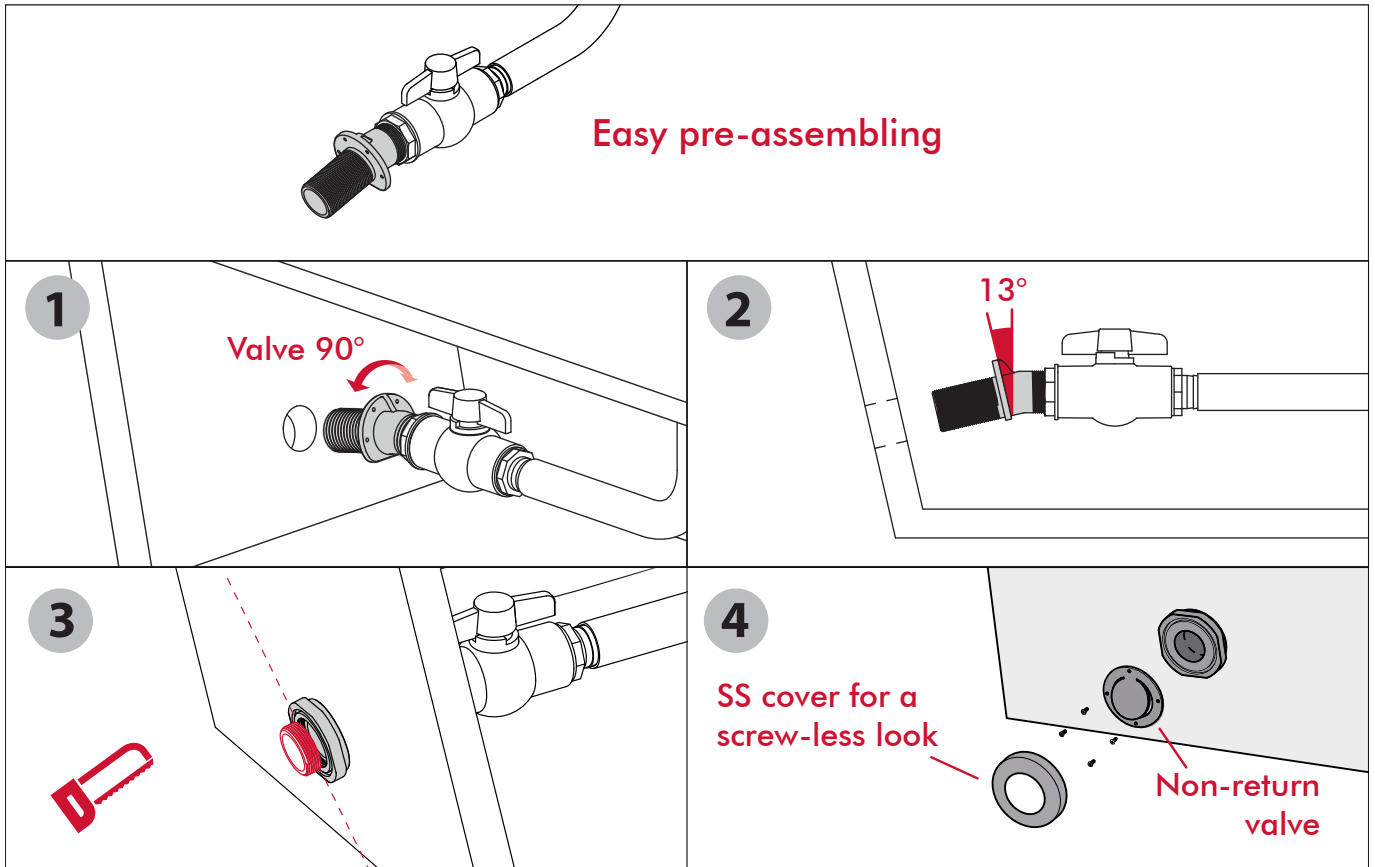

Deluxe XL pull handle

Large and ergonomic grip.
Recess-fit mounting.



Watch the video



Deluxe XL pull latch

FLUSH **ERGONOMIC**

Code **38.511.10**

Handle with wide ergonomic grip equipped with automatic pull-out system and snap lock. For recess-fit mounting. Fitted with anti-vibration closing system. Fixing with M4 studs, no visible screws.

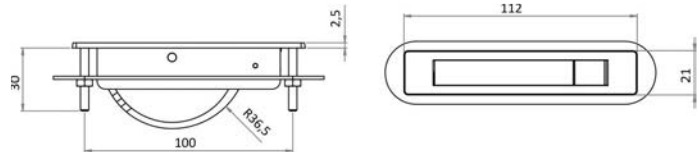
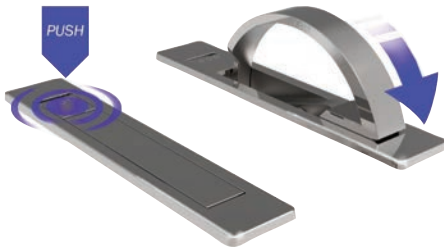

Magnetic door stop

AISI 316 **FLUSH** **PATENTED (UTILITY MODEL)**

Code **38.155.80**

Magnetic door stop made up of two components: Door block with 18° angled magnet and ground block with retractable plate. The magnet lifts the plate when the door is approaching and the block is activated. When not in use, the plate automatically returns to a flat, recessed, obstacle-free position.

Equipped with shock and anti-vibration gaskets and a set of 2 gaskets (2 mm and 4 mm) to adjust the ground block height as required. For 4 to 10 mm floor height doors stops.

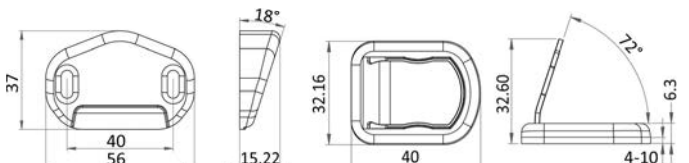
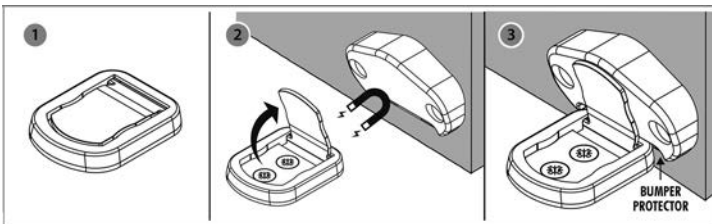

SATURN

no more chills, just chill out

15.470.xx - Shower with *hot/cold* water built-in mixer



 **Cold water only**
Code 15.471.xx



**New Stainless
Steel Base**

Discover more!



OSCULATI

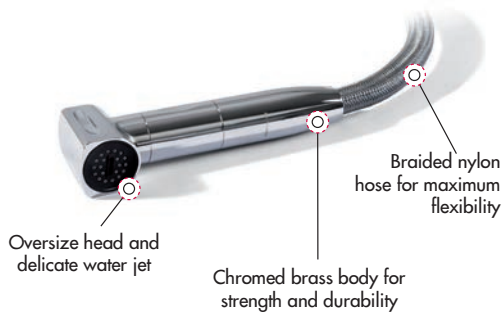

Saturn shower with integrated hot/cold water mixer

REGISTERED DESIGN / DISEGNO DEPOSITATO

HOT & COLD

Shower with built-in mixer. Flat hidden design. Horizontal or vertical mounting. Shower housing fitted with anti-vibration washer. Hot and cold water setting through rotation of the shower body. Water flow regulation by a push lock button that allows to block the water jet and avoid waste. **Built-in mixer for precise temperature setting and maintaining between openings.**

Code	Mounting	Base material	Base color	Type of fastening	Minimum internal space	Flange diameter	Hose m	OPTIONAL carbon fiber shower rod
15.470.01	Horizontal	ABS plastic	white	Locknut	230	84	4	15.480.29
15.470.02	Horizontal	ABS plastic	chromed	Locknut	230	84	4	15.480.29
15.470.11	Vertical	ABS plastic	white	Bonding	160	120	4	15.480.29
15.470.12	Vertical	ABS plastic	chromed	Bonding	160	120	4	15.480.29
15.470.13 New	Vertical	Stainless steel	Glossy	Studs	160	140	4	15.480.29

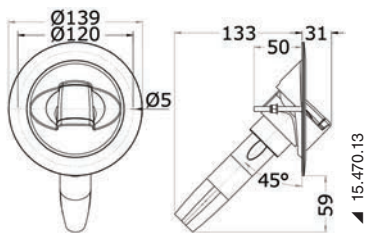

OSCULATI



▲ 15.471.02



▲ 15.471.12



Saturn cold-water shower

REGISTERED DESIGN / DISEGNO DEPOSITATO

ONLY COLD

Flat hidden design. Horizontal or vertical mounting. Shower housing fitted with anti-vibration washer. The flow is adjusted by touching a push lock button that blocks the water jet and prevents waste.

Code	Mounting	Base material	Base color	Type of fastening	Minimum internal space	Flange diameter	Hose m	OPTIONAL carbon fiber shower rod
15.471.01	Horizontal	ABS plastic	white	Locknut	230	84	4	15.480.29
15.471.02	Horizontal	ABS plastic	Chrome Grey	Locknut	230	84	4	15.480.29
15.471.11	Vertical	ABS plastic	white	Bonding	160	120	4	15.480.29
15.471.12	Vertical	ABS plastic	Chrome Grey	Bonding	160	120	4	15.480.29
15.471.13 New	Vertical	Stainless steel	Glossy	Studs	160	140	4	15.480.29

PVC bag for Saturn shower

PVC bag for hose collection and Saturn shower drainage. Ø 16mm hose holder to drain any water infiltrations.
Easily installed on the back of the Saturn shower base using a metal strap.
The two metal rings on the base of the bag allow it to be secured to the hull in the desired position.

Code	To be used with Saturn shower	Codes	Mounting
15.470.90	Vertical mounting base	15.470.11/12 15.471.11/12	with metal strap fixed on the base
15.470.91 New	Horizontal mounting base	15.470.01/02 15.471.01/02	with special ring nut and metal strap

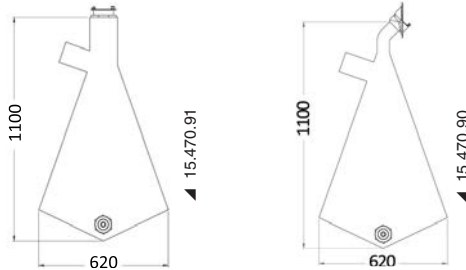

Bulkhead mount bracket for stainless steel showers

AISI 316

Bulkhead mount bracket, adjustable tilt. Made of polished 316 stainless steel. Available in a universal version and a specific version for Saturn showers.

Code	Version	Bracket dimensions mm	Mounting
15.485.01	Universal	89 x 40 x 70	Screws M5
15.485.02	For Saturn	89 x 40 x 70	Screws M5

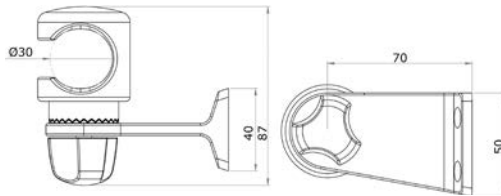

OSCULATI



Bow roller + Trefoil® anchor with anti-water plate

AISI 316

SELF LAUNCHING

Bow roller for anchor with coupling plate for perfect closure of the hull hole. This system makes the plate strike against the roller preventing water from leaking into the forepeak. The roller is designed to match the Trefoil anchor for a combination of high-level products in style and performance. The system can be easily installed by 4 studs behind the roller and is fitted with two sheaves for smooth sliding of the chain. Entirely made of mirror-polished AISI 316 stainless steel. It is recommended to install it on the chain by means of the Twist joint 01.738.01. Windlass ideal pull angle at 5° / 20° from the roller horizontal axis.

Code	Description	←→ mm				kg
		A	B	C	D	
01.120.07	Trefoil anchor 7.5 kg	535	230	352	-	7.5
01.120.10	Trefoil anchor 10 kg	588	331	383	-	10
01.120.15 New	Trefoil anchor 15 kg	650	348	430	-	15
01.120.20	Trefoil anchor 20 kg	702	370	468	-	20
01.121.07	Bow roller 7.5 kg	150	168	232	322	6.3
01.121.10	Bow roller 10 kg	117	203	279	305	9.3
01.121.20	Bow roller 20 kg	206	224	270	254	12.6

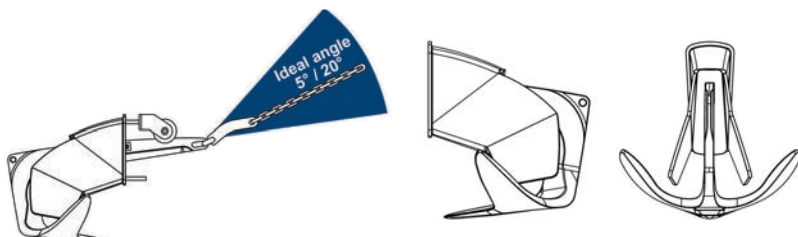

OSCULATI

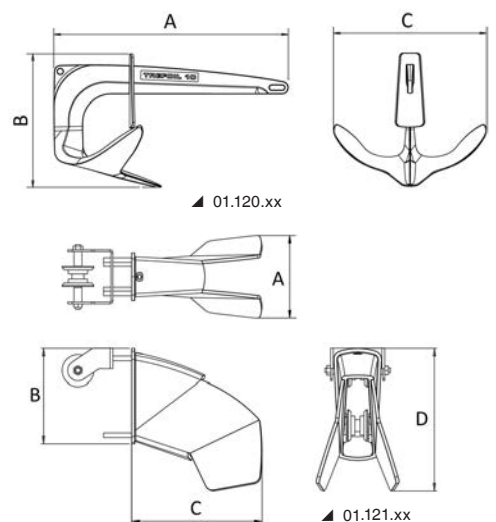

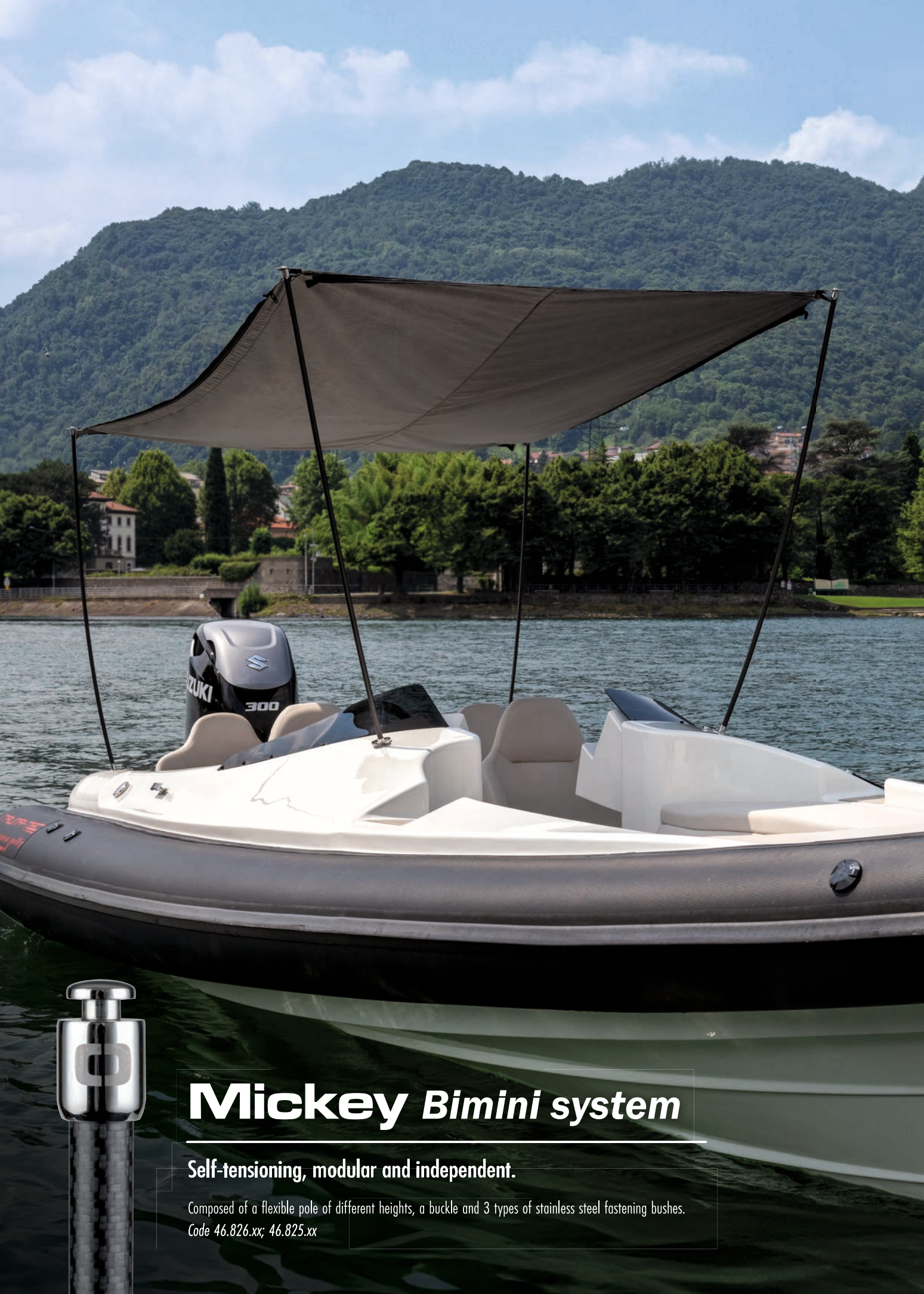

Mickey Bimini system

Self-tensioning, modular and independent.

Composed of a flexible pole of different heights, a buckle and 3 types of stainless steel fastening bushes.
Code 46.826.xx; 46.825.xx

Mickey self-tensioning, modular and independent Bimini system



It can be used as sunshade or water protection and is UV-resistant. Simple to assemble, disassemble and store. It can be installed in many different ways.

The 15°-inclination basis are small and can be easily in different places of the deck depending on the needs and provide a wider coverage than traditional systems.

Much more convenient than the standard systems available on the market (canopy not included).



Mounting base on stainless steel pulpit Mickey system

Code 46.825.10

Stainless steel bushing to be fixed on the pulpit at the point where it crosses the support arm (to prevent the bushing from rotating). Adaptable to pulpits with diameters from 30 to 34 mm and support arm diameters from 25 to 28 mm. Designed with a 15° angle towards the bow or stern and a 12° outward tilt of the vessel to create a self-tensioning system and maximise the size of the awning (screws included).

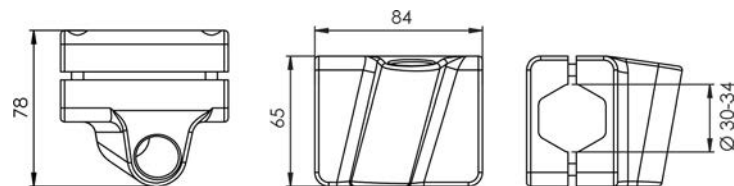

Bimini top with carbon tubes



Bimini top modular system. High finish with mirror-polished swivel-lock bushings.



Recessed bushing for carbon pole with hinge cover

Made of stainless steel with hasp & staple and locking gasket. Water drainage preparation for pipe Ø 12 mm. The closure discreetly protects the glass when not in use. It is possible to customize the cap with a logo upon request.



Code	For poles of Ø mm	Description	←→ mm			
			A	B	C	D
46.814.00	38	Recess-fit bushing, straight	95	141.5	56	74
46.814.01	38	6° angled recessed bushing	95	141.5	56	74
46.814.90	38	Mounting counterflange	100	-	-	-

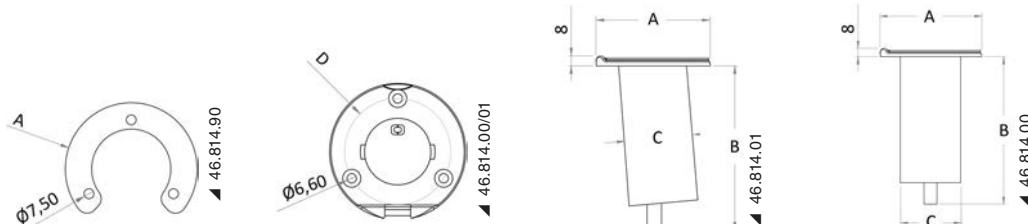



▲ 13.237.20/21/22



▲ 13.237.30/31/32



▲ 13.237.40/41/42



▲ 13.237.22



▲ Electrical diagram



▲ Application

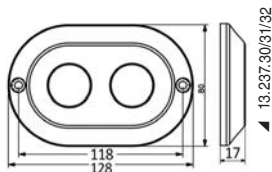

▲ 13.237.30/31/32

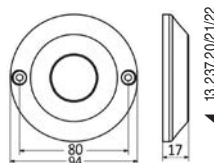

▲ 13.237.20/21/22

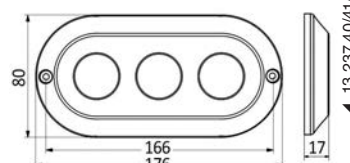

▲ 13.237.40/41/42

LED underwater lights for swim platforms, transoms and hulls

IP68

SOLID S.S. HOUSING

Housing made of solid AISI 316 stainless steel, CNC machined. High-performance latest generation LEDs, scratch-resistant borosilicate glass. Screw mounting, recessless, white or blue single color version with integrated driver 12/24 V. They can be installed in series.

Code	V	No of LEDs	Output power in Watts	lumen	LED colour	↔ mm
13.273.20	12/24	12x5 W	49.3	2951	white	94x17
13.273.21	12/24	12x5 W	49.3	720	blue	94x17
13.273.22	12/24	12x5 W	49.3	725/2867	RGBW	94x17
13.273.30	12/24	24x5 W	85.1	5902	white	127x82.17
13.273.31	12/24	24x5 W	85.1	1440	blue	127x82.17
13.273.32	12/24	24x5 W	85.1	1459/5834	RGBW	127x82.17
13.273.40	12/24	36x5 W	129.6	8853	white	175x82x17
13.273.41	12/24	36x5 W	129.6	2160	blue	175x82x17
13.273.42	12/24	36x5 W	129.6	2197/8796	RGBW	175x82x17

A) Models with fixed white or blue light (excluding RGBW)

Ignition through ON-OFF switch

B) RGBW Models (red/green/blue/white light)

Ignition through 4 ON-OFF switches for each color or through controller 13.237.50 via smartphone bluetooth.

The controller 13.237.50 allows:

- select and mix the four basic colors red/green/blue/white;
- to adjust light intensity;
- to rhythm the light following the onboard music via Bluetooth.

The controller has 4 output cables for 4 colors. The white color can also be achieved by mixing the three colors red/green/blue. The cable dedicated to the white color can thus be freed up and used to insert into the controller the cockpit courtesy lights or other LED lights (up to a maximum of 120 W) that can be controlled, adjusted, timed, etc., via Bluetooth with a smartphone.

The controller supports up to 360 W at 12 Volts. If the total installed power is less than 360 Watts, the system must be completed with an amplifier 13.273.55 for every additional 360 W.

In case of a 24 V power supply system, and only for RGBW lights, a Vage reducer (see Victron or similar) from 24V to 12V must be installed upstream (in case of a AC 220/110V - 12V system) equal at least to the installed power. Multiple voltage reducers coupled to the light groups are also suitable (see electrical diagram).

RGBW Controller for 13.273.XX

RGBW Controller 12/24 V, max capacity 360 W at 12 V and 720 W at 24 V. The controller 13.237.50 allows selecting and mixing the three basic colors red/green/blue, achieving various shades and additionally the white color, it also enables the light to rhythm with the onboard music via bluetooth.

Code	V
13.237.50	12/24

Amplifier for 13.273.XX

Code 13.237.55

Amplifier to pair with lights if installed power exceeds 384 W at 12 V / 768 W at 24 Volts



Underwater lights for swim platforms, transoms and hulls

IP68

SOLID S.S. HOUSING

Stainless steel AISI 316 casing, machined from solid with CNC.
High-performance latest generation LEDs.
Scratch-resistant borosilicate glass diffuser, integrated 12/24 V driver. Recessless screw mounting.
They can be mounted in series, operated by ON/OFF switch.



Code	V	No of LEDs	lumen	LED colour	Ø mm
13.273.01*	12/24	48x3 W	3363 (white) / 599 (blue)	White+Blue	93 x 31
13.273.02**	12/24	48x3 W	636 (red) / 521 (green) / 472 (blue) / 451 (white)	RGBW	93 x 31

- * 13.273.01 selectable: 1) Alternating white or blue light; 2) Steady white or blue light; 3) Flashing white or blue light
- ** 13.273.02 Selectable RGBW: 1) 4 alternating colors automatically in cycles adjustable from 15 seconds to 3 minutes with the option to lock a color; 2) 4 fixed colors to choose from; 3) 4 flashing colors to choose from.

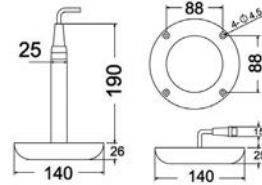

▲ 13.273.02

Underwater LED Light Eye

IP68

Stainless steel AISI 316 casing.
Scratch-resistant borosilicate glass, integrated driver for 12/24 V operation.
Can also operate outside of water; no recess required.



Code	V	No of LEDs	lumen	LED colour	Ø mm
13.273.60	12/24	3x3 W	510	white	80 x 25
13.273.61	12/24	3x3 W	160	blue	80 x 25

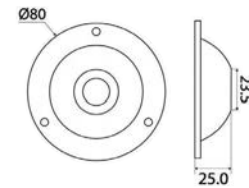

Recessed magnetic support with SCANSTRUT Aura wireless charging - 10 W

IPX6

Built-in wireless charger, designed to withstand the toughest weather conditions.
This device charges the phone wirelessly and also keeps it securely in place.
Your smartphone will effortlessly magnetically lock into the optimal charging position.
Allows phone charging in outdoor environments. No cable required.

- Waterproof Rating: IPX6.
- 10W fast charging.
- Input Voltage Range: 12/24V.
- It fits any boat.
- Instantly start wireless charging, no connection required.

SCANSTRUT



Code	Input V	Output W	↳ mm
14.515.19	12/24	10	124x110x54 (depth)

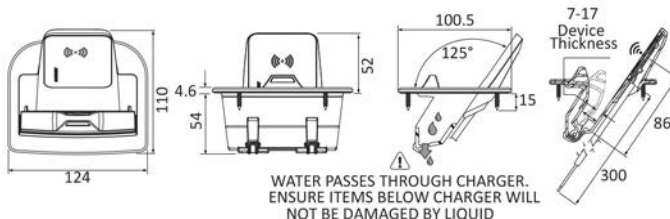



Fixed FIREBOY fire extinguishers with clean agent and manual/automatic activation

USCG

The MA Series fire extinguishers provide optimal protection for engine rooms and motor compartments up to 51 cubic meters. This pre-engineered system ensures a total flooding, representing the safest solution to combat fires in critical environments.

- Automatic activation at 175°F (79°C): in case of emergency, the extinguisher automatically activates at a preset temperature, with the option of manual activation for additional control.
- FK-5-1-12: clean extinguishing agent, ideal for protecting delicate equipment without causing collateral damage.
- Locking lever: increases safety during cable removal or installation.
- Powder coated mounting support: includes a sturdy mounting bracket and a 2-inch LED display for immediate visual control.
- Approved by USCG (United States Coast Guard) and ISO RINA.

Code	Load kg	Protected net volume (m3)	Size	Weight
31.610.03	3	3.5	130x512	8.5
31.610.07	6.1	7	160x514	14.9
31.610.10	8.5	10	180x565	20.1
31.610.14	12.2	14.1	180x769	27.6
31.610.21	17.1	19.8	180x926	35.4
31.610.25	22	25.5	254x781	46.8
31.610.06	4.9	5.7	160x514	12.6
31.610.18	15.8	18.4	180x926	34.2
31.610.22	17.1	19.8	254x623	37.5
31.610.31	26.8	31.1	254x781	52.7

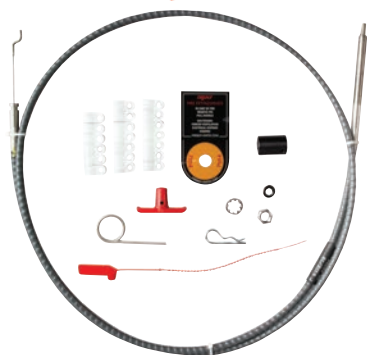

FIREBOY fire extinguisher activation cable kit

The manual FIREBOY function is a backup for those who prefer an additional control measure or for vessels inspected as required by the US Coast Guard regulations. The activation kit includes cable, light indicator, pull handle, safety pin, and safety strap.

Code	Cable length (m)
31.630.03	3
31.630.04	4.2
31.630.05	4.8
31.630.07	7.9
31.630.10	10



FIREBOY ESC series automatic engine shutdown systems

Every system in the FIREBOY ESC series includes an integrated audible alarm, charge/discharge lights, and an override switch to restart or control the automatic shutdown. They are equipped with water-resistant display.

- The ESC Series offers:
- Enclosure ISO 54: robust protection with fuses and internal terminals.
 - Heyco Connectors: for a reliable cable connection.
 - Variety of models with 6, 8, and 10 circuits.
 - Gold-plated 2-amp relays (operational from 10 mA to 2 amps) and 15-amp relays (operational from 100 mA to 20 amps).
 - Multiple voltage 9-12-24-32V DC.

Functions enabled through the control units depending on the boat configuration:

- Turn off the engines.
- Turn off the generator.
- Turn off the blower.
- Turn off power supply pumps.
- Close shutters.
- Turn on alarms.
- Various other functions via the control unit relays.

Code	Model	Relay
31.650.01	6 circuits	2x2A + 4x15A
31.650.02	6 circuits	6x15A
31.650.03	8 circuits	2x2A + 6x15A
31.650.04	10 circuits	10x15A

Oval-section climb-up handle



AISI 316

Oval-section climb-up handle for better grip. Made of mirror-polished 316 stainless steel. Attached by the ladder through studs or plates. Item sold individually (for a pair, order no. 2 pieces).

Code	Description	Dimensions mm	Section mm	Mounting
49.570.00	Climb-up handle	403 x 263	23 x 33	Studs M8 x 50
49.570.01 New	Small climb-up handle	243 x 302	23 x 33	Studs M8 x 50
49.570.90 New	Mounting plates with self-tapping screws	75 x 45	-	Self-tapping screws Ø6

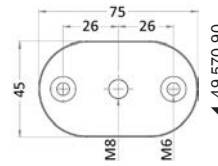
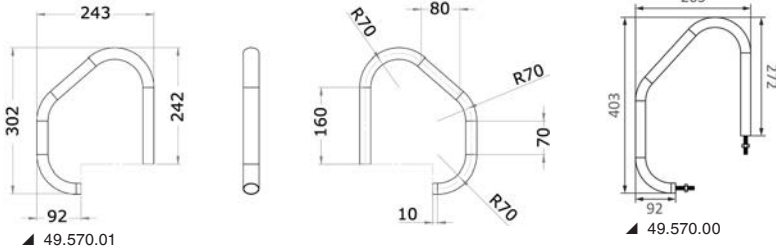

Settable electric touch panel with CAN-BUS controller

MODULAR BACKLIGHT AUTOMATIC FUSE

Modular touch glass panel with backlit symbols. It comes with 40 stickers indicating the different functions to be applied under the glass so that the surface is smooth and gives a print-like effect.

Every switch can be set in 3 different modes:

- Traditional ON-OFF: press a key to activate/deactivate the relating function. E.g.: COCKPIT LIGHTS
- Temporary (ON)-OFF: this function is active only while the key is pressed. Ex. 1: switch – HORN
Ex. 2: switches – WINDLASS UP/DOWN
- ALTERNATE ON-OFF: two keys can be set to activate a function and deactivate another one and vice versa. E.g.: BILGE PUMP IN MANUAL/AUTOMATIC MODE

The keys are backlit in yellow when in standard mode, in blue when the function is active and in red in case of short circuit.

The panels are designed to be modular: if placed side by side in vertical and/or horizontal position, they look like a single built-in panel with 4, 6, 8 (4 + 4), 10 (6 + 4), 12 (6 + 6) switches and so on. The connection between the control unit and the panel is pre-wired with a quick connector. Cable length 1.5m with the option to add an extension of an additional 1.5m.

The MOSFET module is a protection against overloads and voltage inversions. The CAN-BUS is fitted with 4 or 6 thermal fuses that activate in case of short circuit (function key lit in red). The fuse can be reset automatically once the short circuit has been solved and the key is then lit in yellow

CE certified panels, protection rating IP67.



14.691.04

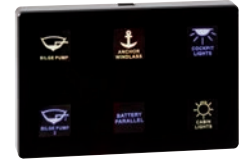

14.691.06



14.691.04/06



14.691.06

14.691.90

Code	N switches	Circuit breaker power	V	panel mm	Ø installation hole mm	Control unit mm	Extension cable 1.5 m
14.691.04	4	1x5A; 2x10A; 1x15A	12/24	62x62x10	16	100.5x152	14.691.90
14.691.05	4	2x10A; 2x20A	12/24	62x62x10	16	100.5x152	14.691.90
14.691.06	6	2x5A; 2x10A; 2x15A	12/24	93x62x10	16	100.5x152	14.691.90



Ut Douglas Marine

DOUGLAS MARINE Simply Fender Profile

Made of 316L stainless steel, mirror polished and tool-flared.
Pickled and passivated to increase corrosion resistance up to five times compared to standard stainless steels.

Code	Description	Bore type	←→ mm			Bars m	Bore centre distance mm	White PVC base	SS end cap	SS top cap
			A	B	H					
44.477.50	Profile 50	flared	48	1.5	8	3	181	44.481.38	44.484.38	44.043.50

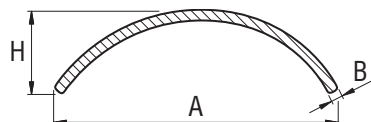

Ut Douglas Marine

PVC base for DOUGLAS MARINE Simply profile

Made of UV-resistant PVC, high quality standards. Tested for quality.
Its particular section ensures maximum cushioning effect and the best aesthetic result, enhancing the stainless profile and minimizing the frame.
Supplied in 24-m rolls.

Code	Colour	←→ mm		Packaging
		A	B	
44.481.38	white	58	19.7	24-m roll

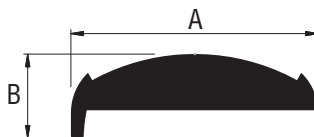

Ut Douglas Marine

Terminal for DOUGLAS MARINE Simply profile

Made of 316L stainless steel, mirror-polished and tool-flared.
Practical and elegant design of the profile terminal.

Code	←→ mm		
	A	B	H
44.484.38	100	64.8	24.6

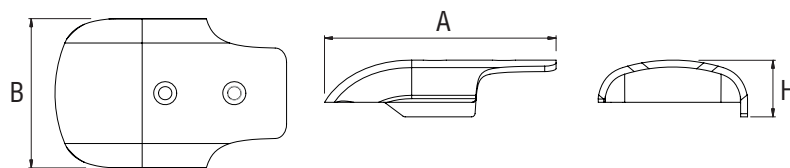

Ut Douglas Marine

Joint Cover for DOUGLAS MARINE Simply Profile

Made of 316L stainless steel, mirror-polished and tool-flared.
Equipped with inside stopper that prevents the profile from slipping and ensures drilling interval consistency.

Code	←→ mm		
	A	B	H
44.043.50	50	4.4	25

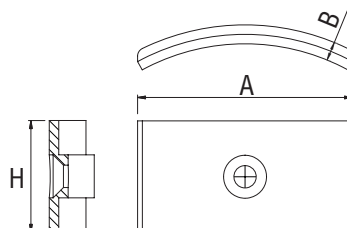

LEWMAR Ultra Low Profile Hatch

It clears your view by minimising clutter.

New ultra-low hatch that combines practicality, aesthetics, and ease of installation.

Sturdy and light frame. The hatch is placed 10 mm above the deck, turning it into a flush setup.

The cut-out dimensions align with those of Low Profile, Medium Profile, and Ocean series; this ensures easy retrofitting without modifications and additional deck drainage.

The lower frame features a silver anodised finish that ensures corrosion resistance in the harshest marine conditions.

LEWMAR®



Code	Size	Recessed flange protrusion mm	↔ outside mm				↔ cutting dimensions (vary using the counterflange) mm			kg	Acrylic thickness mm
			x	Y	Z	R	X1	Y1	R1		
19.210.10	10	25	321	321	10	72.5	260	260	42.5	2.2	12
19.210.20	20	25	263	408	10	72.5	202	347	42.5	2.3	12
19.210.44	44	25	503	503	10	72.5	442	442	42.5	4.8	12
19.210.60	60	25	568	568	10	72.5	507	507	42.5	6.4	12
19.210.70	70	25	688	688	10	72.5	627	627	42.5	9.5	12



RAILBLAZA® battery-operated navigation lights with STARPORT® fastening



RAILBLAZA Starport 360° White Battery-Powered Light

- Visibility up to 2 nautical miles
- USCG 2NM
- Waterproof up to 1 m
- Floats with the light off the water
- Powered by 3 AA batteries
- Operating modes and operating times:
 - Navigation light: up to 25 hours
 - Low brightness: up to 160 hours
 - Flashing emergency – over 200 hours



Code	Cod. Railblaza	Type
11.091.00	02-5004-11	<input type="checkbox"/> White 360°



RAILBLAZA Starport battery-operated signalling kit for Dinghies and kayaks

Regulatory white 360° navigation light for boats under 7 m in length and under 7 knots speed.

- Pole 1 m
- Battery-operated light 3 x AA
- SidePort Mount Included (wall mounting)
- Storage bag with drawstring



Code	Cod. Railblaza	Type
11.092.00	04-4119-11	<input type="checkbox"/> White 360°



RAILBLAZA® fishing gears with STARPORT® fastening



RAILBLAZA Starport bases

Sold complete with gasket and mounting screws.

Code	Cod. Railblaza	Mounting	Dimensions mm	Colour
41.301.00	03-4015-11	flat	Ø64.5	Black
41.301.10	03-4014-11	bulkhead	-	Black
41.301.20	03-4046-11	On Heavy Duty level	99.5 x 52	Black



▲ 41.301.00



▲ 41.301.10



▲ 41.301.00

▲ 41.301.00

▲ 41.301.20

RAILBLAZA Starport bases for pulpits and rails

Complete with rubber gasket to prevent rotation.

Code	Cod. Railblaza	Mounting	Colour
41.303.00	03-4011-11	Tubes 19-25 mm	Black
41.303.10	03-4013-11	Tubes 30-41 mm Panels and rails 32 x 32 Hobie AKA and H-Rail	Black



▲ 41.303.00



▲ 41.303.10



▲ 41.303.00

RAILBLAZA Starport bases for rails and awnings

Does not damage the awning fabric. Not recommended for rod holders.



Code	Cod. Railblaza	Mounting	Colour
41.304.00	03-4165-11	Frames 28 or 32 mm Rods 19/ 22/ 25 mm	Black



RAILBALZA Starport adhesive bases

For gluing on any surface not to be drilled.
3M VHB adhesive for easy installation on Hypalon, PVC, fiberglass, etc.
RIBport can also be glued with two-component adhesive.



Code	Cod. Railblaza	Name	Dimensions mm	Colour
41.305.00	03-4087-11	QuikPort	Ø90	Black
41.305.01	03-4087-21	QuikPort	Ø90	white
41.305.10	03-4064-11	RIBPort	154.5 x 117	Black
41.305.11	03-4064-21	RIBPort	154.5 x 117	white



▲ 41.305.10



Bases for RAILBLAZA Starport guides and rails

Can be fastened without drilling cable trays or TracLoader rails.
For gunnel track systems including Crestliner SureMount, Tracker VersaTrack, Lund Sport Trak, Lowe Boats, Princecraft PrinceTrak, Xpress Boats, War Eagle, G3, Ranger & more • Fits kayak tracks on Hobie, Wilderness, Jackson, YakAttack, Galaxy, Ocean Kayak, Native & more



Code	Cod. Railblaza	Exit	Colour
41.306.00	03-4129-11	Vertical	Black
41.306.10	03-4128-11	Horizontal	Black
41.306.20	03-4145-11	Inclined 45°	Black



▲ 41.306.20



▲ 41.306.10



▲ 41.306.00



RAILBLAZA Starport TracLoader Gunnel Rails

Made of pre-drilled anodized aluminum.

Code	Cod. Railblaza	Dimensions mm	Length mm
41.307.10	01-4156-11	40 X 15	1000
41.307.50	01-4155-11	40 X 15	500



RAILBLAZA Starport MiniPort base for TracMount rails

For kayak rails including Hobie, Wilderness, Jackson, YakAttack, Galaxy, Ocean Kayak and Native Watercraft lines.

Code	Cod. Railblaza	Colour
41.308.00	03-4108-11	Black



41.308.00

RAILBLAZA Starport II rod holder

Robust and highly adjustable to ensure the rod is safe in almost all positions.

- For spinning reels, bait casters, boat reels, and fly reels;
- The rotating collar helps reduce 'sudden jerks';
- End pin to reduce the rod rotation; lift to let the poles slide;
- Swivelling at 360° and 90° in vertical.

Code	Cod. Railblaza	Description	Colour
41.310.00	02-4020-11	Rod holder	Black
41.310.90	02-4137-11	125-mm extension	Black

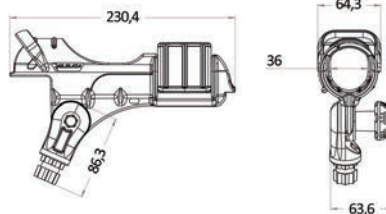

41.310.90



41.310.00



41.310.00



Spinning reels

Fly reels

Bait caster reels



41.310.00



RAILBLAZA Starport R rod holder

A lightweight rod holder for freshwater and coastal fishing.

- For spinning reels, baitcasters, and fly reels.
- Not recommended for towing.
- With safety strap for rod and reel.
- Swivelling at 360° and 90° in vertical.

Code	Cod. Railblaza	Colour
41.311.00	02-4082-11	Black

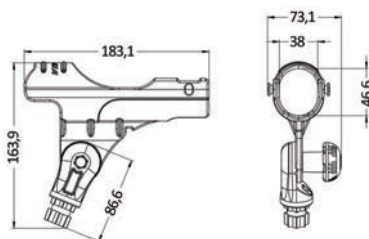

RAILBLAZA Starport Rod Tube rod holder

- For spinning reels, baitcasters, and fly reels.
- End pin to reduce rod rotation; lift to let the poles slide.
- Swivelling at 360° and 90° in vertical.
- Always use a cord on the rod.

Code	Cod. Railblaza	Colour
41.312.00	02-4118-11	Black

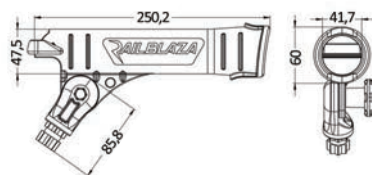

RAILBLAZA Rod Rak rod holder for bulkhead mounting

Robust modular rod holder (can be used singly or in series by fixing it to the nearest one). Suitable for handles from 25 to 38 mm. Can be mounted on bulkhead or ceiling. Rubber inserts for protection purposes. Prepared for an elastic strap (not provided) for a definitive fixing of the rod. Sold in pairs (4 pcs) for 2 rods.

Code	Cod. Railblaza	Colour
41.313.00	09-0008-11	Black
41.313.01	09-0008-21	white

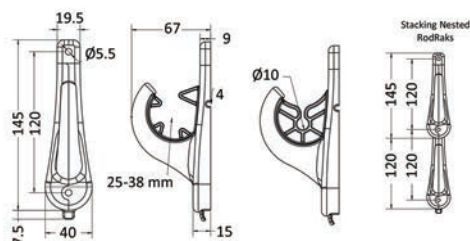

RAILBALZA Rod Stow rod holder for vertical bulkhead mounting

Single or modular rod holder (modules can be connected endlessly).
 Suitable for grips up to 40 mm.
 End stop pin that prevents the rod rotation (removable).
 In the multiple version a compartment is available for bait, tools, and more (between the two rods).

Code	Cod. Railblaza	Mounting	Dimensions mm	Colour
41.314.00	09-0009-11	Single	250 x 60 x 65	Black
41.314.11	09-0009-21	Single	250 x 60 x 65	white
41.314.20	09-0010-11	Double	250 x 220 x 65	Black
41.314.30	09-0011-11	Triple	250 x 375 x 65	Black



RAILBLAZA Starport spooling station

Can be mounted on bulkhead or Starport terminals.
 Swivelling.
 Adjustable tension brake.
 Cable guide.
 Accepts rolls up to 50mm and width 115mm.

Code	Cod. Railblaza
41.315.00	09-4159-11



RAILBLAZA Starport Mount for transducers

Easy removal of the transducer.
 Allows rotation off water even for short distances.

Code	Cod. Railblaza	Description
41.316.00	02-4060-11	For Kayaks and Canoes
41.316.10	02-4086-11	For Kayaks and Inflatables



RAILBLAZA Starport Mounts for FisherFinder

Prepared to accept specific GARMIN instruments or brackets of all brands.

- 360° friction joint.
- Adjustable to fit complex mounting positions.
- Tool-free removal.



Code	Cod. Railblaza	Bracket	Load capacity Kg	Base dimensions mm
41.317.00	02-4178-11	Series 4-7" ECHOMAP Series 5-7" STRIKER	-	-
41.317.10	02-4140-11	For square or round brackets	1.5	102 x 102 h.170
41.317.20	02-4136-11	For U-brackets	-	160 x 60
41.317.30	02-4141-11	For U-brackets	1.5	160 x 60 h.170



41.317.00



41.317.10



RAILBLAZA Starport Mounts for Camera

The best way to preserve your camera and capture the action.

- Fits on threaded chambers ¼ 20.
- Includes adapter for 3-foot GoPro bracket.
- Extension with 5 possible inclinations.



Code	Cod. Railblaza	Bracket	Load capacity Kg
41.320.00	02-4053-11	Camera Mount bracket	-
41.320.10	02-4132-11	Camera Mount + joint and extension up to 650mm	0.8

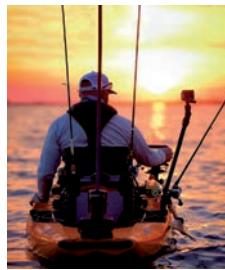

RAILBLAZA Starport Mount for Electric Trolling Motors

Adjustable in all directions.
Foot securing strap that prevents vibrations.
Easy removal to clear the deck.



Code	Cod. Railblaza
41.321.00	02-4158-11



RAILBLAZA Starport Extensions and Accessories for Bases

Code	Cod. Railblaza	Description
41.322.00	03-4016-11	Fixed extension 125 mm
41.322.10	03-4144-11	360° rotatable extension + 15° adjustable tilt
41.322.20	03-4042-11	360° swivel fitting 41-mm extension
41.322.30	02-4147-11	Swivel arm (ideal for extending fishfinders) Length 200 mm - Height 110 mm
41.322.40	02-4043-11	Universal adapter to make every object compatible Starport + Male/Female Adapter



RAILBLAZA Starport Cup Holders and Accessory Holders

Code	Cod. Railblaza	Name	Description	Dimensions mm
41.323.00	02-4040-11	StowPod	<ul style="list-style-type: none"> • Suitable for vertical or horizontal StarPort mounts • Mobile drink holder divider 	255 x 88 x 105
41.323.10	09-4150-11	Equipment carrier "Tackle Caddy"	<ul style="list-style-type: none"> • Ideal for fishing gear including pliers, keys, baits, phones, VHF, binoculars, drink bottles, sunscreen and more. • Contains 2 Stowaway Plano® series 3400 boxes or similar • Elastic cord included to secure tools and boxes • Bulkhead mounting • Compatible with StarPort using adapter 41.322.40 (02-4043-11) 	300 x 115 x 125
41.323.20	02-4048-11	"DrinkHold" cup holder	Carry anything from bottles to coffee cups, plus the option to hang baits or store pliers. Can be mounted horizontally or vertically.	-



41.323.10



RAILBLAZA Starport Tool Holder

Code	Cod. Railblaza	Description
41.324.00	02-4033-11	<ul style="list-style-type: none"> • Securely holds a mobile phone, GPS, VHF, PLB, or other devices. • Spring-loaded arm • Rubber grips • Retention strap
41.324.10	02-4131-11	<ul style="list-style-type: none"> • Securely holds an iPad, a Galaxy tablet, or another device. • Suitable for devices from 4 3/4" to 10" (from 120 to 250 mm). • 360° swivel with lockable R-Lock couplings • Vertical and horizontal display • Tilt angle greater than 90° • Contains hard, soft, and waterproof cases • Rubber grips securely hold devices without slipping or getting damaged.



RAILBLAZA Starport Multifunction Eye Bolt



Code	Cod. Railblaza	Description
41.325.00	02-4003-11	Multi-function eye bolt Ø 25 mm

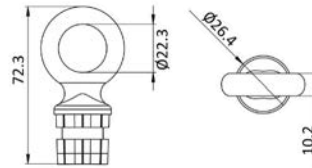

RAILBLAZA Starport Tube Holder with Lock

Suitable for a wide range of equipment such as torches, knife sheaths, boat hooks, oars, gaffs and more.



Code	Cod. Railblaza	For pipe Ø mm
41.326.35	02-4026-11	35
41.326.50	02-4027-11	50

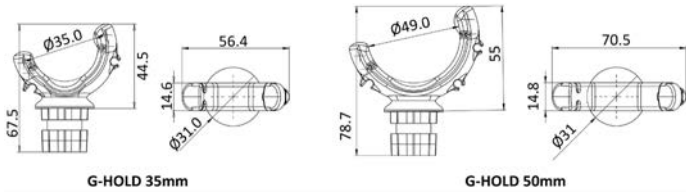

RAILBLAZA Starport Signal Flag

For kayaks, canoes, and off-road vehicles to improve visibility. Fiberglass rod



Code	Cod. Railblaza	Length mm
41.327.00	02-4010-11	1200

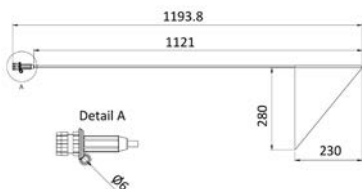

RAILBLAZA® fishing accessories with HEXX® mounting



RAILBLAZA HEXX® Mounts for FishFinder

90° Rotation.
 Room-saving for mounting in confined spaces.
 Easy and quick removal ensures safety on valuable items.
 1 Hexx base included.

Code	Cod. Railblaza	Load capacity Kg	Bracket
41.410.00	11-4174-11	3	90° rotation + 180° tilt
41.411.00	11-4175-11	5	90° Rotation



RAILBLAZA HEXX® Mount for Live Pole 60 Transducers

It perfectly places the soft grip at hip height for easy use.

- 360° rotation of the transducer.
- Fully foldable for storage and save space.
- 1 Hexx base included.
- Storage bag included.

Code	Cod. Railblaza	Open dimensions mm	Dimensions closed mm
41.412.00	11-4190-11	1550	830

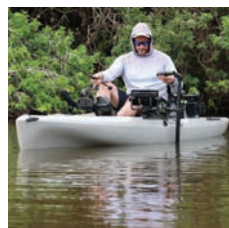



RAILBLAZA HEXX® Heavy Duty Rod Holder

Designed for significant trolling and heavy loads
 For spinning reels, bait casters, boat reels
 The rotating collar helps reduce “sudden jerks”
 End pin to reduce rod rotation
 90° lockable rotation
 High resistance, UV stabilized, engineered polymer construction
 Isolated fastening system to prevent corrosion caused by different metals
 1 HEXX base included
 Always use a cord on the rod

Code	Cod. Railblaza	Colour
41.413.00	11-4189-11	Black



Spinning reels

Bait caster reels

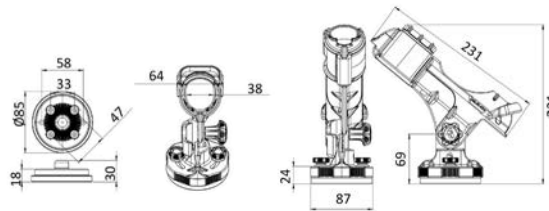

RAILBLAZA Gear Hub Multifunction Box

Gear Hub allows for stowing, transporting, organizing, and protecting everything needed for an excellent fishing session.
 Infinite possibilities for use and customization thanks to adaptable Railblaza accessories.
 Suitable for shore fishing, beach, kayak, canoe or boat fishing.

- 4 integrated rod holders in the corners.
- It contains 8 Plano 3600 or similar.
- 9 Guide Tracks prepared for Railblaza accessories.
- Multiple attachment and anchoring points.
- Integrated handles.
- Non-slip rubber feet.
- Entirely stainless hardware.
- Hinged lid with locking closure.

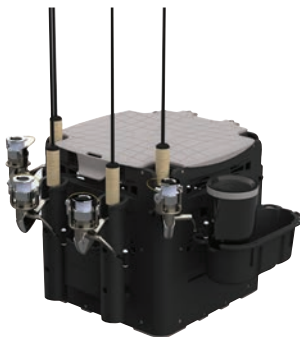

Code	Cod. Railblaza	↳ mm	kg
47.350.00	09-4227-11	330 x 330 h.330	2.75



Kayak and Canoe Carts C-TUG® by RAILBLAZA®



RAILBLAZA Kiwi C-TUG Cart with Wheels

C-TUG is a robust cart suitable for all terrains. Market-leading design. No tools required. To be assembled and disassembled in seconds. Sized to be stowed in kayak hatches.

- It disassembles in a few seconds.
- Fits inside hatches.
- Hull rubber padding.
- Tool-free assembly.
- Kiwi puncture-proof wheels with rubber tread.
- Strap 2.8 m with aluminium buckle.
- Adjustable stand.
- 5 years warranty.

Code	Cod. Railblaza	kg	Static load capacity Kg
47.341.01	50-001-71	4.3	120

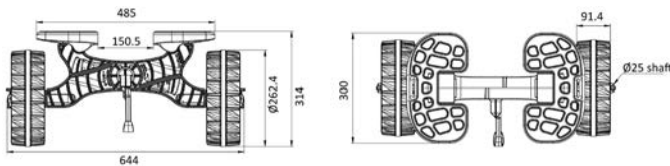

RAILBLAZA C-TUG R Cart

C-Tug R is the evolution of the market leader C-Tug. Thanks to adjustable support rails, it adapts to all hulls ensuring maximum balance during towing.

- It disassembles in a few seconds.
- Stowed inside hatches.
- 20" (500 mm) support rails with non-slip rubber bearings.
- Made of sturdy reinforced polymer.
- Stainless steel reinforced axles.
- Kiwi puncture-proof wheels or SandTraKz for sandy or smooth surfaces (ensure high glide and ease of transport).
- Strap 2.8 m with aluminium buckle.
- Adjustable stand.
- 5 years warranty.

Code	Cod. Railblaza	kg	Static load capacity Kg	Version
47.341.10	50-0010-71	4	100	Kiwi Wheel (all terrain)
47.341.14	50-0014-71	4.6	80	SandTraKz (sand or smooth surfaces)
47.341.90	50-0012-71	-	-	C-TUG to C-TUG R Conversion Kit



47.341.10

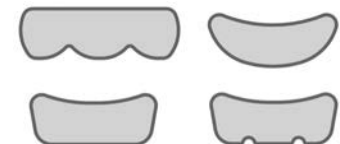

▲ Suits hull shapes with these typical cross section



47.341.14



47.341.10

OSCULATI portable navigation lights



Multifunction navigation lights, 3 X AAA power supply (not included). IP66 waterproof, floating. Suitable for boats, kayaks, inflatables and canoes. Comply with COLREG 72 directive.

Navilight 2NM 360° white light

2 operating modes: 360° fixed light (10h operation time), 360° flashing light (16h operation time)

Code	Swivel (with swivel)	Model
11.139.41	Yes	3 bases included: 1) Base for surface mounting with screws (included) 2) Adhesive base for attachment on inflatable boat tubes 3) Adapters for GoPro® supports
11.139.42	no	With magnetic base to be fixed with screws or adjustable strap
11.139.43	Yes	With suction cup base, compatible with GoPro® mounts



▲ 11.139.41



▲ 11.139.41



▲ 11.139.41



▲ 11.139.42



▲ 11.139.42



▲ 11.139.42



▲ 11.139.43

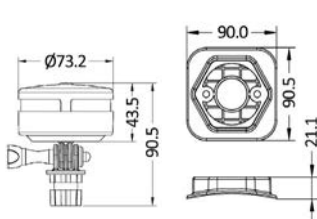

▲ 11.139.41

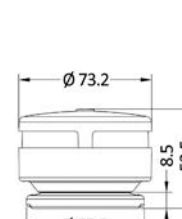
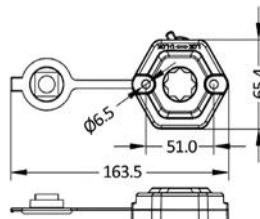

▲ 11.139.42

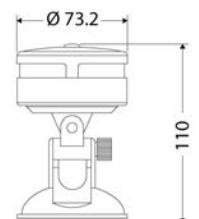

▲ 11.139.43

Navilight 360° Bi-colour Light 1NM

3 operating modes: Red light 112.5° (16h autonomy), Green light 112.5° (16h autonomy), Red+Green light 112.5°+112.5° (10h autonomy).

Code	Swivel (with swivel)	Model
11.139.44	Yes	3 bases included: 1) Base for surface mounting with screws (included) 2) Adhesive base for attachment on inflatable boat tubes 3) Adapters for GoPro® supports
11.139.45	no	With magnetic base to be fixed with screws or adjustable strap
11.139.46	Yes	With suction cup base, compatible with GoPro® mounts



▲ 11.139.44



▲ 11.139.44



▲ 11.139.44



▲ 11.139.45



▲ 11.139.45



▲ 11.139.46

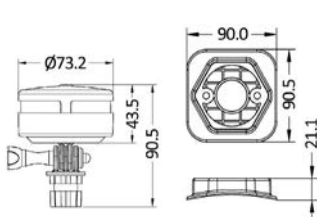

▲ 11.139.44

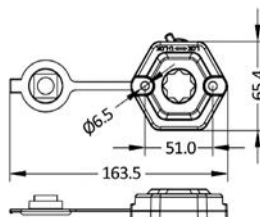

▲ 11.139.45

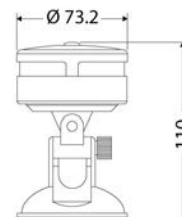
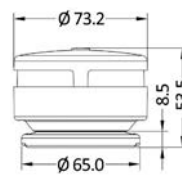

▲ 11.139.46

VICTRON battery chargers and devices



VICTRON TG microprocessor battery charger

3-stage IUOU charge with microprocessor that perfectly adapts the charge to the battery requirements (very important function in case of sealed batteries). Two isolated outlets, the second (4 A) dedicated to the starting batteries. Battery temperature compensation automatic system (it extends the life of sealed batteries).

Technical data: 180/264 VAC - 180/400 VDC - 45/65 Hz power supply; Aluminium housing; Internal temperature sensors + battery temperature sensor; Forced ventilation; Protections against short circuit, polarity inversion, overheating.

Code	Model	Type	V output/ input	Max charging current A	Number of outputs	Recommended for batteries A-h	↔ mm	kg
14.267.01	TG	24/30	28.5 / 230VAC	30 + 4	1 + 1	150/300	365x250x147	5.5
14.267.02	TG	24/50	28.5 / 230VAC	50 + 4	1 + 1	250/500	365x250x147	6.5
14.267.30 New	TG	24/80	28.5 / 230VAC	80 + 4	1 + 1	400/800	365x250x257	10
14.267.31 New	TG	24/100	28.5 / 230VAC	100 + 4	1 + 1	500/1000	365x250x257	10



▲ 14.270.37



▲ 14.270.30



▲ 14.270.33



▲ 14.267.01/02



▲ 14.100.06

14.270.37 SKYLLA control panel. It monitors the charge level and enables to reduce outlet AC current if the inlet AC power is low.

14.270.33 Remote chargeswitch

14.270.30 Battery alarm panel: audio/visual alarm in case of high/low voltage.

14.100.06 BMV-700 Battery monitor

VICTRON VE.Net GMDSS remote panel

Code 14.267.35

The GMDSS panel ensures easy access to all important data and allows for integrated control of operation and potential malfunctions.

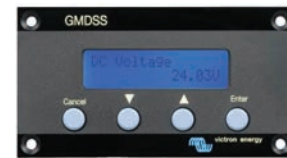

VICTRON Quattro combo system - Battery charger + Inverter

Same functions of the Multiplus system, but it can be connected to 2 independent AC sources (eg. dock and generator or 2 generators) and the Quattro system will **automatically** connect to the active source.

Code	Type	AC Input (2x)	Power supply V-DC	Inverter		Battery charger		Number of outputs	↔ mm	kg
				Power V-A	V-AC Output	charging voltage	Battery charging current A			
14.268.10	12/3000/120	187/265	9.5 - 17	3000	120	14.4	14.4	1+1*	362x258x218	19
14.268.11	24/3000/70	187/265	19 - 33	3000	70	28.8	28.8	1+1*	362x258x218	19
14.268.13	24/5000/120	187/265	19 - 33	5000	120	28.8	28.8	1+1*	444x328x240	30
14.268.14**	24/8000/200	187/265	19 - 33	8000	200	28.8	28.8	1+1*	470x350x280	41
14.268.20 New	12/5000/120	180/270	9.5 - 17	5000	230	14.4	14.4	1+1*	470x350x280	34

* Second 4A outlet dedicated to the starting batteries.
** Only available on order.

14.270.32 Digital Multicontrol. Control panel for both inverter and battery charger. Possibility to manage the inlet current when switching from dock supply to generator supply. It can manage parallel and three-phase devices. It can be configured with several VE-BUS remote systems. Cable RJ45 needed.

14.100.06 BMV-700 Battery monitor

14.270.47 RJ45 7-m cord to complete 14.270.39.

14.270.39 VE-Bus --> USB interface for computer connection.



▲ 14.270.32



▲ 14.100.06



▲ 14.270.47



▲ 14.270.39

VICTRON GX series control panel

It provides control and monitoring (also in remote mode) of VICTRON devices. All readings on the screen can be forwarded to a remote computer via an external router (WebBoat4G PLUS, not included) for both monitoring and configuration. The GX series supports the following products: Inverter/Multi/Quattro/Skylla-i/Control panels/Battery monitors.

Code	Model	Version
14.070.50	Control GX	With colour display
14.070.51	Control VENUS GX	Without display
14.070.60 New	Ekrano GX	Touchscreen



▲ 14.070.50



▲ 14.070.60



▲ 14.070.51

OSCULATI



Europump Next Generation submersible bilge pump

CE-certified in compliance with the ISO 8846/8849 directive.
Extremely compact in size, fitted with backflow **check valve**.
Removable hose connector adjustable at 360°.

Code	V	Model	Flow l/min	Current draw A	Head m	Hose adaptor Ø mm	90° Hose holder Ø 29 mm OPTIONAL
16.128.01	12	600	38	2.5	2.5	19/29	16.128.00
16.128.05	12	1100	70	4.0	4	25/29	16.128.00
16.128.06	24	1100	70	2.5	4	25/29	16.128.00
16.128.07	12	1500	96	4.5	5	29	16.128.00
16.128.08	24	1500	96	2.5	5	29	16.128.00
16.128.09	12	2000	128	7.5	5.5	29	16.128.00
16.128.10	24	2000	128	4	5.5	29	16.128.00

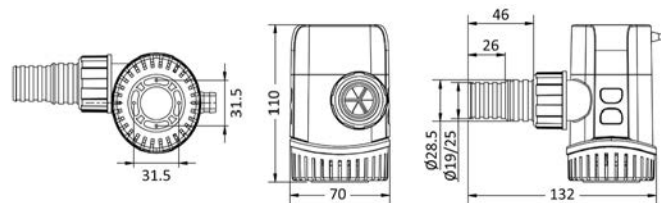

OSCULATI



Europump Next Generation automatic submersible bilge pump

CE-certified in compliance with the ISO 8846/8849 directive.
Compact in size, fitted with an electronic timer sensing automatic system to check the presence of water every 2.5 minutes for a duration of 0.5 seconds.
Removable hose connector adjustable at 360°.
Fitted with backflow **check valve**.

Code	V	Model	Flow l/min	Current draw A	Head m	Hose adaptor Ø mm	90° Hose holder Ø 29 mm OPTIONAL
16.129.01	12	600	38	2.5	2.5	19/29	16.128.00
16.129.03	12	750	51	3.5	3.0	19/29	16.128.00
16.129.04	24	750	51	2.0	2.0	19/29	16.128.00
16.129.05	12	1100	70	4.0	4.0	25/29	16.128.00
16.129.06	24	1100	70	2.5	2.5	25/29	16.128.00
16.129.07	12	1500	96	4.5	5	29	16.128.00
16.129.08	24	1500	96	2.5	5	29	16.128.00
16.129.09	12	2000	128	7.5	5.5	29	16.128.00
16.129.10	24	2000	128	4	5.5	29	16.128.00

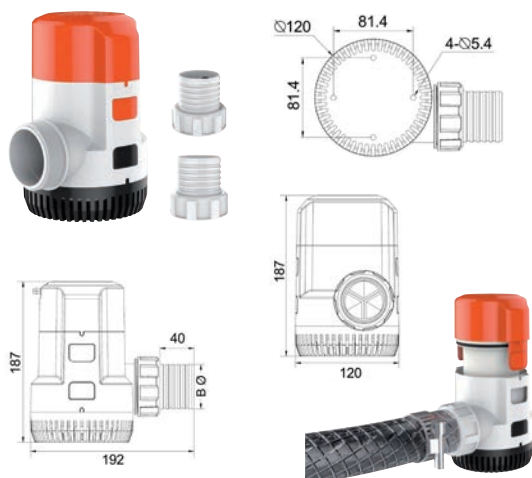
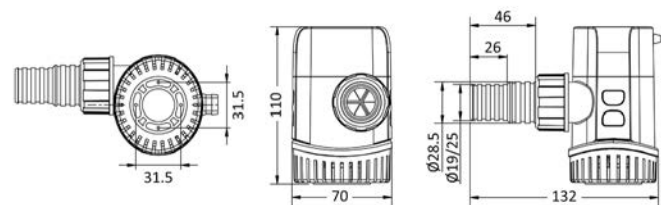

Maxi submersible bilge pump

Compliant with CE/ISO 8846-8849 and RoHS standards.
Silent, with stainless steel shaft and valve that prevents water backflow and blockage due to air pockets
Removable filter for easy cleaning.
The new quick connection system allows the motor to be extracted without disconnecting the base and hydraulic connections.
Automatable through any automatic switch (at least 20A).

Code	Model	V	Max flow rate l/m	Current draw A	Maximum head m	ø base mm	Height mm	Hose holder B ø mm
16.122.37	New 3700	12	233	14	6	120	187	52
16.122.38	New 3700/24	24	233	7	6	120	187	52
16.122.45	New 4700/12new	12	296	16	6.5	120	187	52
16.122.46	4700/24new	24	296	8	6.5	120	187	52

Automatic electronic switch for bilge pumps

Universal for all submersible pumps operating at 20A max current draw and 12/24 V. It switches ON at a 41-mm level and turns OFF at 9.5-mm level. A 3-second delay system prevents false starts. To be installed both horizontally and vertically.

Code	Level ON/OFF mm	V	Max A	mm
16.610.01	41/9.5	12/24	20 (12V)/10 (24V)	92x22x63h

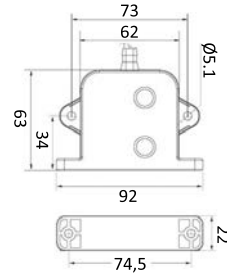

ATTWOOD Tsunami MK2 electric pump for aeration and water recirculation



For use in catch and bait tanks; mounted directly on the transom mirror or remotely with a pipe. Version with **two outputs** for simultaneous ventilation of 2 tanks or one tank by using the second connection for deck washing. Cartridges compatible with previous versions of Attwood aerator pumps. Easy and quick installation without the use of sealants. ISO 8846 and IP68 certified

Code	Model	Version	V	Flow l/min	Current draw A	Hose adaptor	OPTIONAL sea intake	OPTIONAL filter	OPTIONAL spray head	Hose holder OPTIONAL
16.411.01	564X/T500	in line	12	38	1.6	3/4"	16.388.61	16.388.50	16.412.53	17.235.02 / 17.236.02
16.411.02	564X/T500	inside mounting	12	38	1.6	3/4"	16.388.61	16.388.50	16.412.53	17.235.02 / 17.236.02
16.411.03	564X/T500	through bulkhead at 90°	12	38	1.6	3/4"	16.388.61	16.388.50	16.412.53	17.235.02 / 17.236.02
16.411.04	565X/T800	in line	12	50	2.9	3/4"	16.388.61	16.388.50	16.412.53	17.235.02 / 17.236.02
16.411.05	565X/T800	inside mounting	12	50	2.9	3/4"	16.388.61	16.388.50	16.412.53	17.235.02 / 17.236.02
16.411.06	565X/T800	through bulkhead at 90°	12	50	2.9	3/4"	16.388.61	16.388.50	16.412.53	17.235.02 / 17.236.02

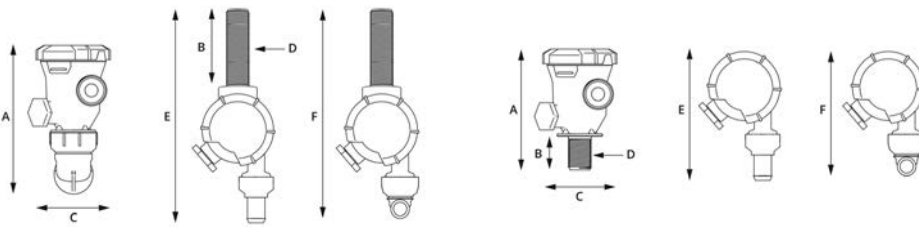

Electric battery pump for liquid transfer

Suitable for transferring gasoline, diesel, kerosene, water, and light oils. Autonomous operation with rechargeable lithium battery via USB with included cable. Explosion-proof motor and overload protection. Auto shut-off sensor for full tank. Various sizes of fittings to screw onto the withdrawal tank. Control LED to indicate battery activation status.

Code	Flow l/min	Max extraction m
16.235.00	12	2.5 / 1 (light oils)



Recirculation pumps for air conditioning systems

To be used in AC systems over 12,000 BTU. Over 10,000 hours of continuous operation, low noise level. Can run dry with normal workloads. Can replace any brand of marine pumps for air conditioning systems

Code	V	Frequency Hz	BTU-h	Flow l/min	Head m	Watt	Entrance	Exit
16.531.01	220	60	12.000	18.5	2.7	55	3/8" - 3/4"	3/4"
16.531.02	220	60	24.000	31	4.3	105	1/4"	1/2"

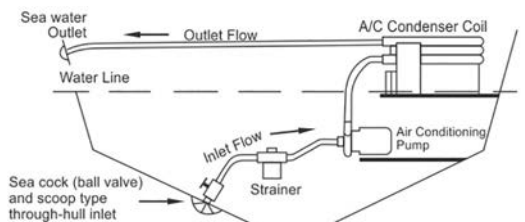
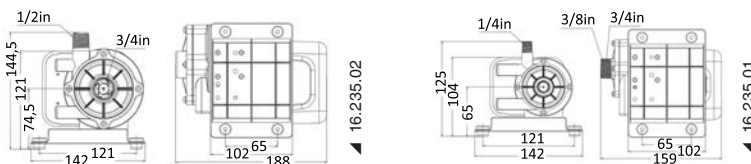



Water intake from the dock and pressure regulator

Limits and levels the water pressure from the dock to 3.1 bar to avoid damaging autoclaves and piping.
Kit consisting of water intake + quick snap-on connection for water ingress + rear hose holder.

Code	Version	Entrance	Exit	↔ mm
16.441.22	recess	3/4"	1/2"	117 x 117

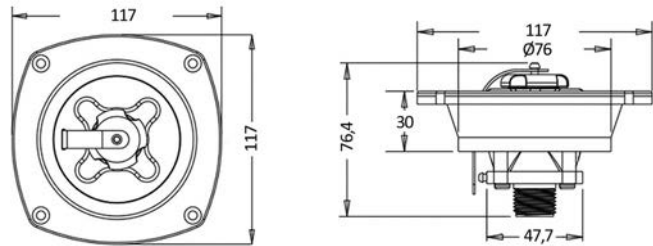

John Guest Speedfit quick coupling system for watertight water installations

John Guest Speedfit quick-connect range of products uses the technology of the combined action of clip and seal.

The clamp with stainless steel teeth grips the tube and the O-Ring thus provides an airtight seal.



Product description	15-mm Ø	22-mm Ø
Female / Female Coupling	17.114.01	17.116.01
90° female/female elbow	17.114.02	17.116.02
90° female tee	17.114.03	17.116.03
1/2" female/female brass joint	17.114.04	-
3/8" female/female brass joint	17.114.26	-
3/4" female/female brass joint	-	17.116.04
3/8" female/male brass joint	17.114.05	-
1/2" female/male brass joint	17.114.06	-
3/4" female/male brass joint	-	17.116.06
1/2" T brass joint for connection to accumulator tanks, boilers, etc.	17.114.07	17.116.17
3/4" T brass joint for connection to accumulator tanks, boilers, etc.	-	17.116.18
1/2" female/female brass elbow	17.114.24	-
3/4" female/female brass elbow	-	17.116.24
1/2" female/male brass elbow	17.114.25	-
3/4" female/male brass elbow	-	17.116.25
22x15-mm male/female reduction	-	17.116.29
22x15x22-mm reduced T	-	17.116.31
Male/female manifold with two 22x15x15x22 derivations, openable at the end	-	17.116.33
Male/female manifold with three 22x15x15x22 derivations, openable at the end	-	17.116.35
22x22x15-mm reduced T	-	17.116.37
Bush to fit into the tube, NECESSARI to censure seal (Ø15 = technopolymer; Ø22 = stainless steel)	17.114.11	17.116.40
Spare silicone O-ring	17.114.17	17.116.43
150-mm Ø curve with fastening screw	17.114.19	-

Sole recessed LED ceiling light

ABS body, technopolymer diffuser.

Code	Finish	V	W	Switch	lumen	K	LED beam angle	No of LEDs	Light colour
13.877.80	White	8/28	2.2	no	155	3000	120°	12 LED SMD	<input type="checkbox"/> white
13.877.81	White	8/28	2.2	Yes	155	3000	120°	12 LED SMD	<input type="checkbox"/> white
13.877.82	Golden	8/28	2.2	no	155	3000	120°	12 LED SMD	<input type="checkbox"/> white
13.877.83	Golden	8/28	2.2	Yes	155	3000	120°	12 LED SMD	<input type="checkbox"/> white
13.877.84	Chromed	8/28	2.2	no	155	3000	120°	12 LED SMD	<input type="checkbox"/> white
13.877.85	Chromed	8/28	2.2	Yes	155	3000	120°	12 LED SMD	<input type="checkbox"/> white



▲ 13.877.84/85



▲ 13.877.80/81

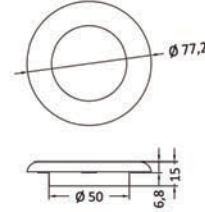

▲ 13.877.82/83

Ultra-compact LED courtesy lights, minimalist look - downwards

IP67

Front and back waterproof model. Complete with rear cable gland, 1m-cable and waterproof micro connector.

Light orientation downwards. Recess hole diameter 17 mm.

Body material:

A = matt black anodized aluminum;

B = polished white painted aluminium;

C = mirror-polished stainless steel.

Code	V	W	Body material	Light colour	Hole Ø	mm
13.182.10	12	1	A	<input type="checkbox"/> white	17	Ø26x36
13.182.11	12	1	A	<input checked="" type="checkbox"/> blue	17	Ø26x36
13.182.13	12	1	B	<input type="checkbox"/> white	17	Ø26x36
13.182.14	12	1	B	<input checked="" type="checkbox"/> blue	17	Ø26x36
13.182.16	12	1	C	<input type="checkbox"/> white	17	Ø26x36
13.182.17	12	1	C	<input checked="" type="checkbox"/> blue	17	Ø26x36



▲ 13.182.11



▲ 13.182.13



▲ 13.182.16

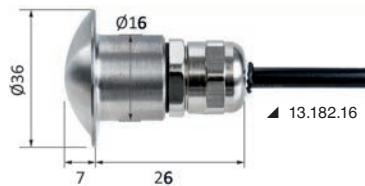

▲ 13.182.16

OSCULATI recessed LED courtesy lights

IP65

In technopolymer, complete with gasket.

Body colour		V	W	lumen	K	No of LEDs	Light colour	mm		
<input type="checkbox"/> white	<input checked="" type="checkbox"/> Chromed							Ø Recess	External Ø	Overhang
13.887.11	13.887.13	12	0.21	15	3000	1	<input type="checkbox"/> White	14	45x31	7
13.887.12	13.887.14	12	0.21	5	-	1	<input checked="" type="checkbox"/> Blu	14	45x31	7

OSCULATI

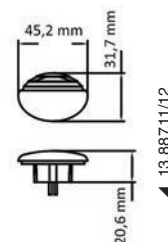

▲ 13.887.11/12



▲ 13.887.13/14



13.490.21/22/31/32

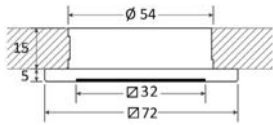

Dimmable Bos recessed LED light with reduced depth

IP66

Polycarbonate housing with ring. Satin diffuser. Single central LED. Screw fixing. 13.490.01/02 with fixed or dimmable light. See the table to choose the ideal switch.
13.490.11/12 with dimmable light, (ON/OFF + dimmer) touch function included in the glass.

Type	Recommended switch types	Recommended switch models	Dimmable
A	ON/OFF	Any	no
A	Touch dimmer	14.482.00	Yes
B	ON/OFF	Any	no
B	Momentary on switch	14.215.05/06.13/14; 14.482.01 or similar	Yes

Ring		Type	V	W	Switch	lumen	K	LED beam angle	No of LEDs	Light colour
Polished stainless steel	Polished white technopolymer									
13.490.01	13.490.21 New	A	12/24	2	no	170	3000	80°	1	<input type="checkbox"/> white
13.490.02	13.490.22 New	B	12/24	2	no	170 + 40	3000	80°	1	<input checked="" type="checkbox"/> White + red night
13.490.11	13.490.31 New	-	12/24	2	Yes, dimmable touch switch	170	3000	80°	1	<input type="checkbox"/> white
13.490.12	13.490.32 New	-	12/24	2	Yes, dimmable touch switch	170 + 40	3000	80°	1	<input checked="" type="checkbox"/> White + red night



13.489.21/22/31/32

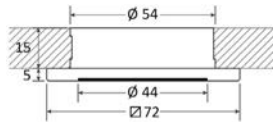

Propus dimmable reduced-depth recessed LED light

IP66

Polycarbonate housing with ring. Satin diffuser. Single central LED. Screw fixing. 13.489.01/02 with fixed or dimmable light. See the table to choose the ideal switch.
13.489.11/12 with dimmable light, (ON/OFF + dimmer) touch function included in the glass.

Type	Recommended switch types	Recommended switch models	Dimmable
A	ON/OFF	Any	no
A	Touch dimmer	14.482.00	Yes
B	ON/OFF	Any	no
B	Momentary on switch	14.215.05/06.13/14 or similar	Yes

Ring		Type	V	W	Switch	lumen	K	LED beam angle	No of LEDs	Light colour
Polished stainless steel	Polished white technopolymer									
13.489.01	13.489.21 New	A	12/24	2	no	170	3000	80°	1	<input type="checkbox"/> white
13.489.02	13.489.22 New	B	12/24	2	no	170 + 40	3000	80°	1	<input checked="" type="checkbox"/> White + red night
13.489.11	13.489.31 New	-	12/24	2	Yes, dimmable touch switch	170	3000	80°	1	<input type="checkbox"/> white
13.489.12	13.489.32 New	-	12/24	2	Yes, dimmable touch switch	170 + 40	3000	80°	1	<input checked="" type="checkbox"/> White + red night



13.488.21/22/31/32

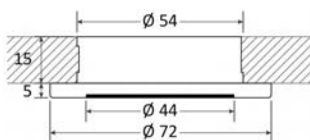

Polis dimmable reduced-depth recessed LED light

IP66

Polycarbonate housing with ring. Satin diffuser. Single central LED. Screw fixing. 13.488.01/02 with fixed or dimmable light. See the table to choose the ideal switch.
13.488.11/12 with dimmable light, (ON/OFF + dimmer) touch function included in the diffuser.

Type	Recommended switch types	Recommended switch models	Dimmable
A	ON/OFF	Any	no
A	Touch dimmer	14.482.00	Yes
B	ON/OFF	Any	no
B	Momentary on switch	14.215.05/06.13/14 or similar	Yes

Ring		Type	V	W	Switch	lumen	K	LED beam angle	No of LEDs	Light colour
Polished stainless steel	Polished white technopolymer									
13.488.01	13.488.21 New	A	12/24	2	no	170	3000	80°	1	<input type="checkbox"/> white
13.488.02	13.488.22 New	B	12/24	2	no	170 + 40	3000	80°	1	<input checked="" type="checkbox"/> White + red night
13.488.11	13.488.31 New	-	12/24	2	Yes, dimmable touch switch	170	3000	80°	1	<input type="checkbox"/> white
13.488.12	13.488.32 New	-	12/24	2	Yes, dimmable touch switch	170 + 40	3000	80°	1	<input checked="" type="checkbox"/> White + red night

LED spotlight with USB-C and switch.

Frosted glass diffuser

Code	Finishing	V	W	Switch	lumen	K	Light colour
13.438.92	Polished stainless steel	12/24	1x3	Yes	92	3000	white
13.438.93	Polished and protected brass	12/24	1x3	Yes	92	3000	white

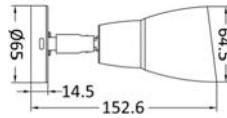

Articulated LED spotlight

Complete with USB-C port, 2 A.
Touch ON-OFF switch with night light and dimmer to adjust light intensity.

Code	Finishing	V	W	Switch	Dimmer	material	lumen	K
13.867.30	polished	12	2	Yes	Yes	Chromed aluminium	270	3200
13.867.31	Black	12	2	Yes	Yes	Black aluminium	270	3200



Articulated LED spotlight

Complete with USB-C port, 2 A.
ON-OFF switch, material: chromed aluminium.

Code	Finishing	V	W	Switch	lumen	K	Length mm
13.867.35	Polished	12	2	Yes	290	3000	240
13.867.45	Polished	12	2	Yes	290	3000	400

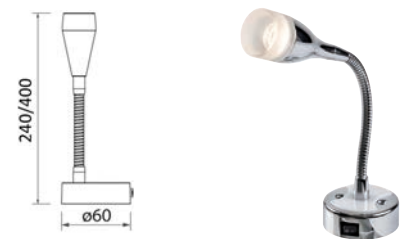

Articulated LED spotlight

Complete with USB-C port, 2 A.
Touch ON-OFF switch with night light and dimmer to adjust light intensity.
Material: black aluminium.

Code	Finishing	V	W	Switch	Dimmer	lumen	K	Length mm
13.867.36	Black	12	2	Yes	Yes	280	3000	220
13.867.46	Black	12	2	Yes	Yes	280	3000	400



LED spotlight

Complete with USB-C port, 2 A.
Touch ON-OFF switch with night light and dimmer to adjust light intensity.
Material: aluminium with stainless steel satin finish.

Code	Finishing	V	W	Switch	Dimmer	lumen	K
13.867.38	Satin-finish	12	2	Yes	Yes	280	3000
13.867.39	Black	12	2	Yes	Yes	280	3000





Classic electric spotlight with console-operated joystick



13.225.49; 13.226.49



13.225.50



13.226.50



13.227.51



13.225.31

Body: diecast aluminium coated in white high-resistance anti-corrosion resins. Totally watertight. 2-speed 355° horizontal rotation. 50° vertical rotation.

Version A: 100W+90W double filament halogen bulb (spot + flood).

Version B: ultra-powerful HID Xenon gas discharge bulb (35W HID).

Protection against electronic interference.

Headlights can be connected to 2 types of optional controls (independent or combined) for the desired configuration:

- 1) Console-operated joystick. 4.5-m cable included. Additional joystick controls to be installed via the 2-port cable 13.227.51.
- 2) Traditional remote control with bracket for console fixing. Range up to 40 m from the lighthouse.

Code	V	CD candles*	W	lumen	Range 025 lux	Joystick control INCLUDED or 2nd control	OPTIONAL wireless remote control	Connection cable for second joystick 4.5m	10-m extension cable for OPTIONAL Joystick	Spare bulb
13.225.01	12	180.000	100+90	2500	849	13.225.49	13.225.50	13.227.51	13.225.31	13.225.35
13.225.02	24	180.000	100+90	2500	849	13.225.49	13.225.50	13.227.51	13.225.31	13.225.36
13.224.01	12	315.000	35	3200	1122	13.226.49	13.226.50	13.227.51	13.225.31	13.224.32
13.224.02	24	315.000	35	3200	1122	13.226.49	13.226.50	13.227.51	13.225.31	13.224.32

* To be measured at the centre of the light beam.

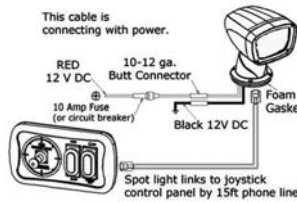
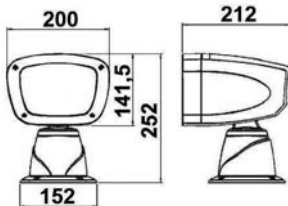
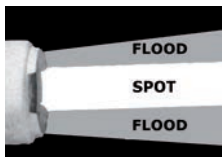

13.225.39; 13.226.39

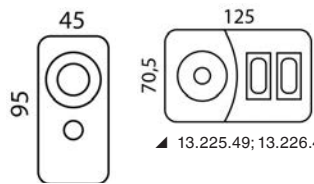

13.225.50; 13.226.50



13.225.49; 13.226.49



Classic electric SS spotlight with console-operated joystick

IP67

Mirror-polished stainless steel body. 100% watertight. 350° horizontal and 55° vertical rotation. Two speeds. 100W + 90W H4 halogen double-filament bulb (spot + flood). Protection against electronic interference.

Headlights can be connected to 2 types of optional controls (independent or combined) for the desired configuration:

- 1) Console-operated joystick. 4.5-m cable included. Additional joystick controls to be installed via the 2-port cable 13.227.51.
- 2) Traditional remote control with bracket for console fixing. Range up to 40 m from the lighthouse.

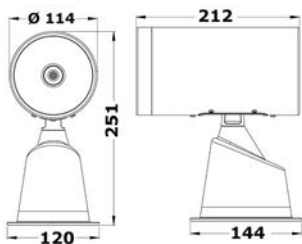

13.227.51



13.225.31

Code	V	CD candles*	W	Range 025 lux	Joystick control INCLUDED or 2nd control	OPTIONAL wireless remote control	Connection cable for second joystick 4.5m	10-m extension cable for OPTIONAL Joystick	Spare bulb
13.229.01	12	135.000	100/90	775	13.225.49	13.225.50	13.227.51	13.225.31	13.225.35
13.229.02	24	135.000	100/90	775	13.225.49	13.225.50	13.227.51	13.225.31	13.225.36

* To be measured at the centre of the light beam.

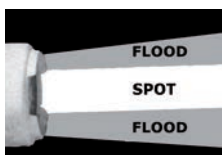

13.225.49

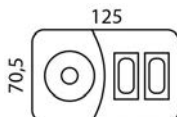

13.225.49



13.225.50



13.225.50

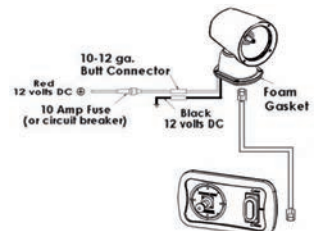



LED searchlight complete with console-operated joystick

Body: diecast aluminium coated in white high-resistance and anti-corrosion resins. 100% watertight. 2-speed 355° horizontal rotation. 50° vertical rotation. CREE high-quality LED unit. 54W consumption corresponding to a traditional 100 W bulb. Protection against electronic interference.

Headlights can be connected to 2 types of optional controls (independent or combined) for the desired configuration:

- 1) Console-operated joystick. 4.5-m cable included. Additional joystick controls to be installed via the 2-port cable 13.227.51.
- 2) Traditional remote control with bracket for console fixing. Range up to 40 m from the lighthouse.



Code	V	CD candles*	W	K	lumen	No of LEDs	LED beam angle	Range 025 lux	Joystick control INCLUDED or 2nd control	OPTIONAL wireless remote control	Connection cable for second joystick 4.5m	10 m extension cable for Joystick
13.226.01	12	132.000	54	6000	6000	18	9°	726	13.226.49	13.226.50	13.227.51	13.225.31
13.226.02	24	132.000	54	6000	6000	18	9°	726	13.226.49	13.226.50	13.227.51	13.225.31

* To be measured at the centre of the light beam.



Battery cables, made of copper and coated with synthetic resin insulating covering



Made in accordance with EC standards for use in bilges.

black	red	Section mm	Maximum continuous current A	External Ø mm	Sheath thickness mm	Roll m
14.381.16 New	14.382.16 New	16	75	8.7	1.7	24
14.381.25	14.382.25	25	100	9.5	1.8	24
14.381.35	14.382.35	35	125	12	1.8	24
14.381.50	14.382.50	50	160	14	2	24
14.381.70	14.382.70	70	250	16	2	24
14.381.90	14.382.90	95	300	21	2.4	24

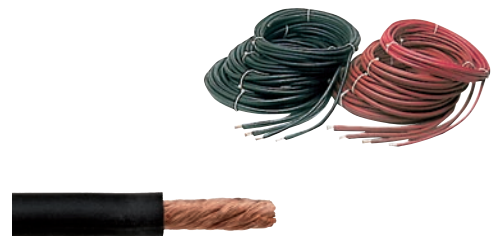

Power lugs

Made of made of high conductivity tin-plated copper.

Code	Cable cross-section mm ²	D3 mm	L mm	D4 mm	D2 mm	D1 mm	ORDER BY BOX	Tool for attaching terminals to electrical cables
14.035.11	10	13.5	30.5	8.3	4.7	6.5	100	14.035.30
14.035.17	16	13.5	31	8.3	5.6	7.5	100	14.035.30
14.035.52	50	18	49	13	9.5	13	20	14.035.30

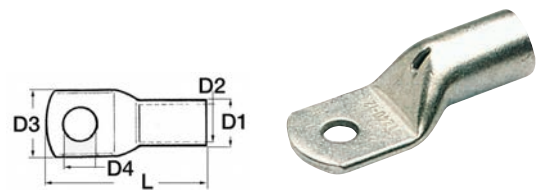

Lighter and/or USB socket

Made of nylon and fit with protection cap to make them waterproof. 12/24V input, 5V USB output.

black	Description	A
14.516.14	Cigarette lighter socket + USB-A + USB-C + fairing for mounting on a surface	2.4+2.4*

*3+3 A if used one at a time

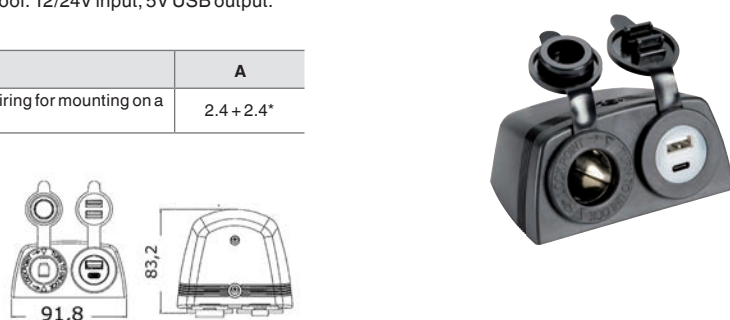



High-visibility floating mooring lines with reflective strand

REFLECTIVE STRAP

FLOATING

Polypropylene lines suitable for mooring in bays and with lines on the ground. Being floating, they make it easy to manage the boat and haul it onshore. Slightly elastic, acting as mooring shock absorbers. The strand being yellow and reflective is highly visible at night to bathers and other boats.

yellow	Ø mm	Breaking load kg	Weight kg/100 m	mm
06.481.14	14	1900	8.3	200
06.481.18	18	2800	14.3	200
06.481.22	22	4400	21.5	200
06.481.26	26	5900	30.6	200

OSCULATI



Deluxe rubbing strake

AISI 316

SOLIDS.S.

They protect against rubbing of the mooring lines. Made of thick mirror-polished AISI316 stainless steel. Available in two versions: with screws or studs.

Code	Length A mm	Width B mm	Mounting	Bore Ø mm	Centre distance mm
06.336.32	320	15	Screws (4)	4	95
06.336.50	500	15	Screws (6)	4	95
06.337.32	320	15	Studs M5x40 (2)	-	290
06.337.50	500	15	Studs M5x40 (3)	-	235
06.339.50 New	500	28	Studs M5x40 (3)	-	235

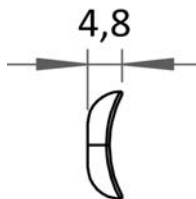

OSCULATI



Specter foldable step

MAGNETIC LOCK

Code 59.807.00
Wide foldable step with non-slip grip made of CNC machined aluminum. Bright silver anodized finish. Magnetic closing and locking system. EPDM gasket for closure cushioning. The step can be attached to the mast or any flat surface using 2 M6 screws (not provided)

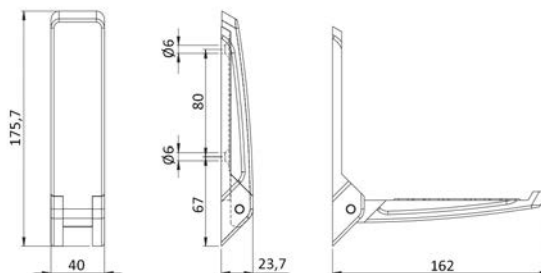

▲ 02.356.04



▲ 02.356.05

MZ ELECTRONIC Meter Panel

Compact meter counter, easy to install and compatible with any windlass. Measurements in meters or feet. To be used in combination with other control up-down equipment (02.315.30 or 14.192.03 + 14.193.14 or similar).

Code	mm	OPTIONAL magnetic sensor	V
02.356.04	65x65	02.355.00 (if necessary)	-
02.356.05 New	65x60	-	12/24

Pearl stainless steel lever latch

AISI 316

MADE IN ITALY

PATENT PENDING

The operating mechanism is enclosed within the main casing, thus presenting an impeccable **aesthetic** result. Features an intermediate elastic system that allows for a consistently usable and pleasant trigger tension, capable of compensating for any variations that may occur during work. It is entirely made of stainless steel **AISI 316**, mirror-polished finish on the outside and a bright finish on the inside.

For the latch fastening, what follows is required:

- 2 M4 countersunk screws for the base plate,
- 2 M5 rounded head screws for the hooking tooth.

Code	A mm	B mm	C mm	D mm
38.202.00	106	38	20	3

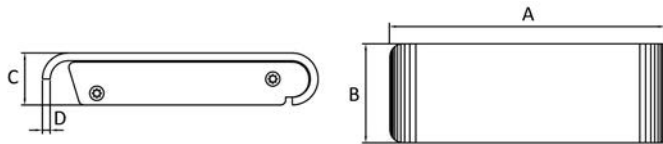

OSCULATI



Low-profile pop-up cleat

AISI 316

PATENT / BREVETTATO

A compact and ergonomically designed solution. Made of **stainless steel AISI 316**, mirror-polished. Easy to install, no recess required. US patent model M617040.

Code	Mounting	Length mm	Width mm	Centre distance mm	Overhang mm	Breaking load kg
40.146.10 New	Studs Ø 6x43 mm (included)	115	38	67	15	700
40.146.11 New	Studs Ø 8x46 mm (included)	143	48	52	18	1200
40.146.12 New	Studs Ø 8x52 mm (included)	166	55	115	20	1300
40.146.13 New	Studs Ø 8x53 mm (included)	204	65	137	24	1800
40.143.10	Screws Ø 6 mm (not included)	115	38	67	15	700
40.143.11 New	Screws Ø 8 mm (not included)	146	48	92	18	1200
40.143.12	Screws Ø 8 mm (not included)	166	55	115	20	1300
40.143.13 New	Screws Ø 10 mm (not included)	204	65	137	24	1800



Thor cleat

Made of polished aluminium. Complete with stud.

Code	A mm	B mm	C mm	D mm	E mm	Stud Ø mm
40.109.16	83	Ø 60	42	160	34	12

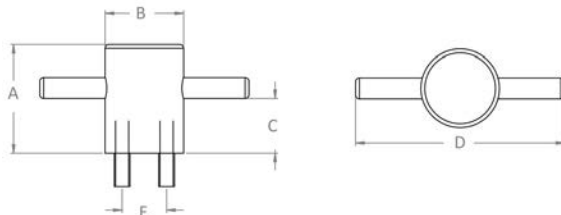

Black Aero cleat

Black anodized aluminium. Fitted with studs (T).

Code	L mm	H mm	E mm	T mm	T2 mm
40.102.15	158	35	45	M10x70	50
40.102.20	208	38	60	M10x70	50
40.102.25	258	45	68	M12x75	50
40.102.30 New	308	51	78	M14x80	50

OSCULATI



OSCULATI



▲ 33.517.12



▲ 33.517.21

Small Fender Model

In pre-inflated PVC.

Colour		Model	Length cm	←→ cm				kg
white	blue			A	B	C	D	
33.517.11	33.517.21	angular	25	8.5	7.4	12	3.9	0.6
33.517.12	33.517.22	straight	43	8.5	7.4	12	3.9	0.56

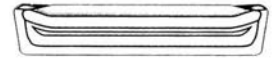
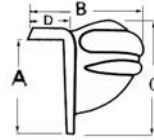
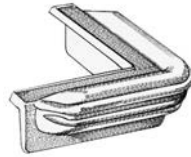

OSCULATI



▲ 33.519.68

Medium Fender Model

In PVC with a needle valve.

Colour		Type of fastening	Length cm	Section cm	kg
white	blue				
33.519.63	33.519.64	on plane	93	15x10	2.6
33.519.67	33.519.68	vertical (support ear)	39	15x10	1.2

OSCULATI



▲ 33.519.60



▲ 33.519.61

Big Fender Model

In PVC with a pin valve. Mounting on a plane plus angle.

Colour		Length cm	Section cm	kg
white	blue			
33.519.60	33.519.61	87	25x19.5	4.2

OSCULATI



▲ 33.519.70

Inflatable Corner model with valve

In PVC with a needle valve.

Colour		Ø cm	Length cm	kg
white	blue			
33.519.70	33.519.71	18.5	39	1.5

Flat fenders

In soft closed-cell foam PVC, with an outer coating of coated and welded PVC fabric. They can be folded for easier storage.

Colour		←→ cm	Thickness cm
white	black		
33.515.01	33.515.11 New	60 x 16	6
33.515.02	33.515.12 New	81 x 16	10

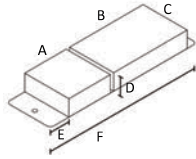

▲ 33.515.11/12



▲ 33.515.01/02

Heavy Duty Polyethylene Mooring Buoys

Scratch-resistant glossy surface.
Complete with central axle in RILSAN-coated steel.
High precision lower swivel.
Filled with closed-cell polyurethane foam.

Colour		Ø cm	Circumference cm	Body length cm	Total length cm	Thrust kg
white	red					
33.178.01	33.177.01	46	142	55	90	56
33.178.02	33.177.02	55	178	65	92	107



▲ 33.177.02



▲ 33.178.01

GIANT Heavy Duty Polyethylene Mooring Buoys

Scratch-resistant surface.
Complete with central shaft, diameter 30 mm, in RILSAN-coated steel.
High-strength lower swivel.
Filled with closed-cell polyurethane foam.

red	Ø cm	Body length cm	Total length cm	Thrust kg
33.179.01	91	121	170	650
33.179.02	116	121	170	1100



▲ 33.179.02



▲ 33.179.01

Lighting kit for WINDEX®

Code **35.388.08**

WINDEX LED Light illuminates the reflectors on the indicator arms and on your Windex, for easy reading even at night.
The silver, water-repellent and corrosion-resistant components ensure a longer lifespan and only 23 mA power consumption.
Suitable for mounting with WINDEX 15, WINDEX 10, and WINDEX XL.



Hazard warning stickers and loading/unloading points

Code	Description	←→ mm
35.464.04	Load of petrol sticker	25x27
35.464.14	Load of diesel sticker	25x27
35.464.05	Load of water sticker	25x27
35.464.06	Fire hazard sticker	25x27
35.464.07	Electric Hazard Sticker	25x27



▲ 35.464.06



▲ 35.464.05



▲ 35.464.04



▲ 35.464.14



▲ 35.464.07

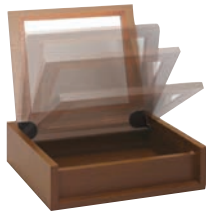

Hinge with integrated damper

Hinge with integrated damper to prevent lid closure
 For doors opening upwards.
 Side-mount type. Sold in pairs (DX+SX).
 Includes countersunk self-tapping screws 4x20mm.

Code	Colour	Torque
38.613.01	black	3.4 - 5 N•m (34.7 - 51 kg•cm)

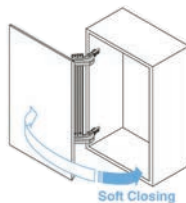

SUGATSUNE MonoFlat LIN-X Hinge

MonoFlat LIN-X450 hinge with lateral rotation mechanism.
 Allows lateral rotation of doors within reduced radius. Ideal for limited front space applications (electrical panels in corridors).
 The door does not impede clear space when fully open, providing full access to the cabinet.
 Free rotation and cushioned closure **Soft Close**. Simple installation, adjustable in 4 ways.

Code	Version	Hinge overall mm	Plate for overall dimension mm	For doors thickness mm
38.528.01	Overlap 19 mm	285x55	47x46	15/24

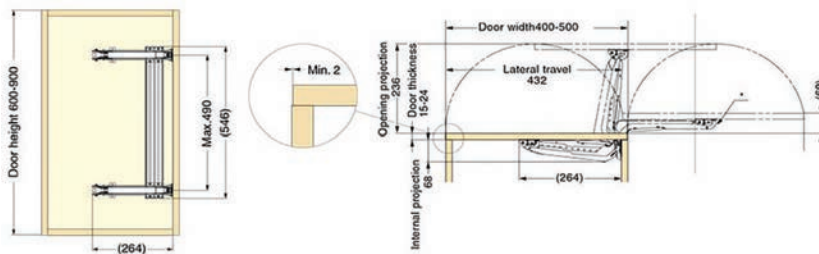

Pin hinge side mounting

Made of **chrome-plated brass**, complete with bushing.

Code	mm	Version
38.395.01	18 X 35	Right
38.395.02	18 X 35	Left
38.397.01	35 X 60	Right
38.397.02	35 X 60	Left

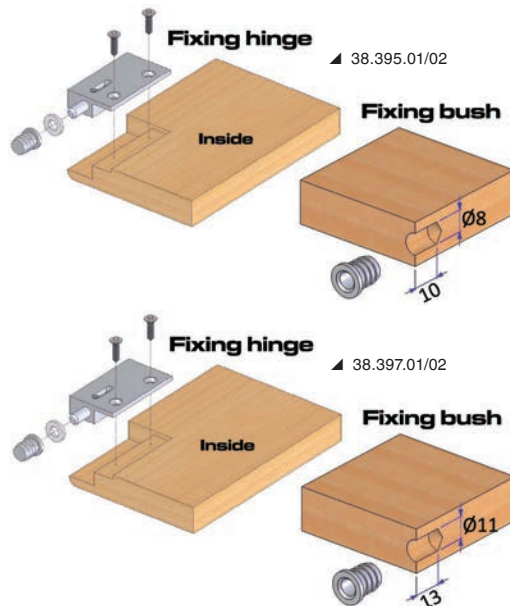
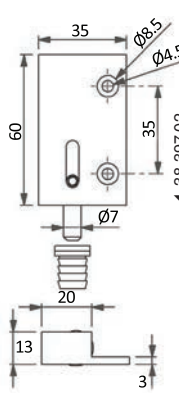
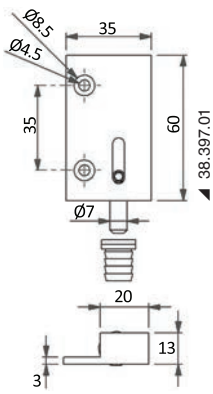
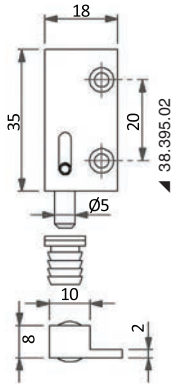
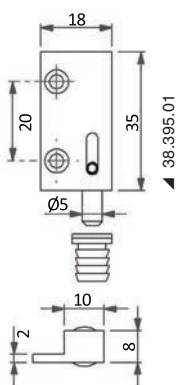
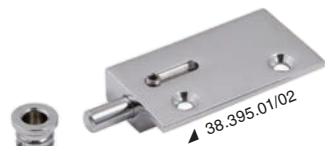

Adjustable magnetic doorstop



Code	Version	Description
38.155.00	chromed brass	Standard magnetic resistance 4.1 Kg
38.155.01	Stainless Steel 316 mirror-polished	Standard magnetic resistance 4.1 Kg
38.155.10 New	chromed brass	GIANT magnetic resistance 7.5 Kg

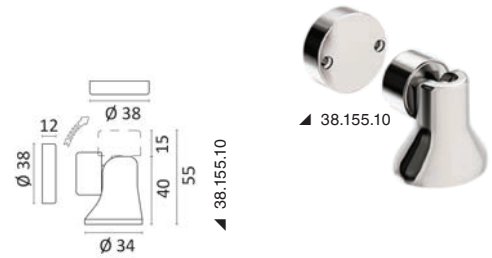

Door bumpers

Made of chrome-plated brass and rubber for shock absorption

Code	↔	
	Ø mm	Thickness mm
38.155.25	25	24
38.155.40	40	27

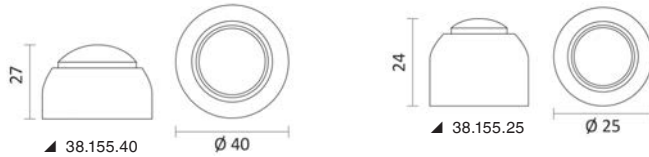

SUGATSUNE non-magnetic contact latch

ABS body. For doors without knobs or handles.
Non-magnetic.
Latch release travel of about 1.5 mm.



Code	Colour	Retaining force N
38.194.01	black	29

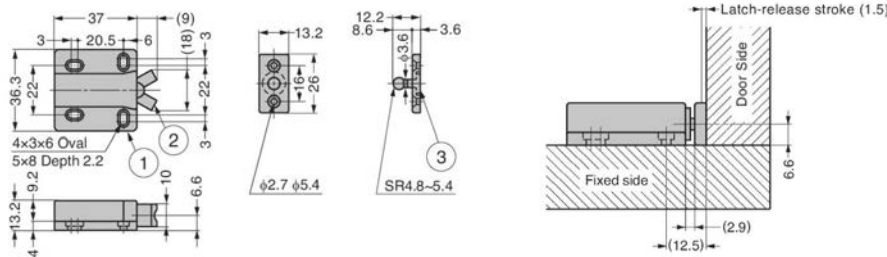

SUGATSUNE non-magnetic contact latch with floating door stop

ABS body. For doors without knobs or handles.
Floating collision for easy alignment.
Non-magnetic.
Latch release travel of about 3 mm



Code	Colour	Retaining force N
38.199.01	black	78
38.199.02	white	78

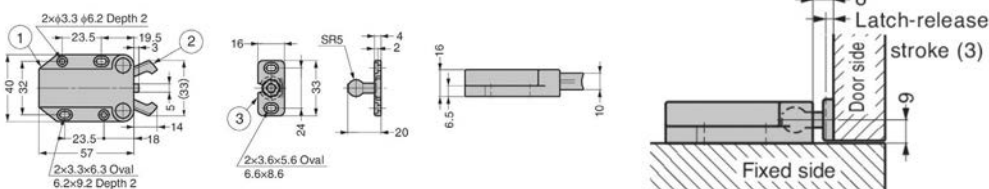

External stainless steel hob units

Fitted with safety thermocouples.

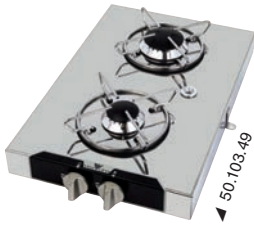

▲ 50.103.49

Code	No of burners	↔ outside mm	Burner W	OPTIONAL pot holder
50.103.45	1	210x290x90h	1750	50.100.91
50.103.47	2	440x290x90h	1900+1000	50.100.92
50.103.49 New	2	290x440x90h	1900+1000	50.100.92



▲ 50.100.92

Gas hob with pyroceram burners

Fitted with safety thermocouple.



▲ 50.706.10



▲ 50.706.15

Code	No of burners	↔ mm		Power W	Column pot holder OPTIONAL
		outside	recess		
50.706.10 New	1	365x195	345x180	1800	50.100.91
50.706.11	1	325x290	270x305	1900	50.100.91
50.706.12	2	500x300	480x280	1750+3000	50.100.92
50.706.13	2	380x280	360x260	1000+1750	50.100.92
50.706.15 New	3	400x400	380x380	1000+1800+1800	50.100.93
50.706.14	3	504x410	484x390	1000+1900+3000	50.100.93



▲ 50.100.91



▲ 50.100.93

Cooktops with steel glass lid

Stainless steel cooktops with smoked tempered glass lid, complete with hot and cold water mixer tap.



▲ 50.714.01



▲ 50.714.02



▲ 50.714.03



▲ 50.714.04

Code	With sink	No of burners	↔ mm			Burners W	OPTIONAL pot holder
			outside	inside	recess depth		
50.714.01	right	1	526x326	515x325	163	1800	50.100.91
50.714.02	left	1	526x326	515x325	163	1800	50.100.91
50.714.03	right	2	726x346	688x319	140	1800+1000	50.100.92
50.714.04	left	2	720x346	688x319	140	1800+1000	50.100.92

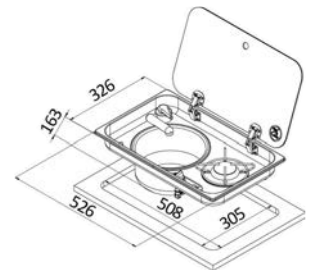

▲ 50.100.92



▲ 50.100.91

Thermoelectric cooler 12V

This thermoelectric cooler is a state-of-the-art cooling device designed to ensure the ideal temperature for wine bottles and other beverages up to a diameter of 92 mm. A thermoelectric cooling system made up of copper tubes and a heat sink ensures even temperature distribution and optimal performance. The cooler is equipped with a modern touch control panel and display that makes it simple and intuitive to manage temperature setting. It comes with a plug and cigarette lighter adapter.

Code	Capacity	V	Power W	Bore Ø mm	Depth mm
50.860.01	1 Bottle	12	72	92	190



TECMA Silence Plus 2G Black Edition Electric Toilet

Total Black versin of the WC Silence Plus 2G (Generation2) complete with black Touch SFT control panel.



Code	Model	V	←→ mm			Built-in bidet	Installation	kg
			Height	Width	depth			
50.227.47	Silence Plus 2G	12	460	390	510	no	Above floor	25.5
50.227.41	Silence Plus 2G	24	460	390	510	no	Above floor	25.5
50.227.46	Silence Plus 2G+Bidet	24	460	390	510	Yes	Above floor	25.5

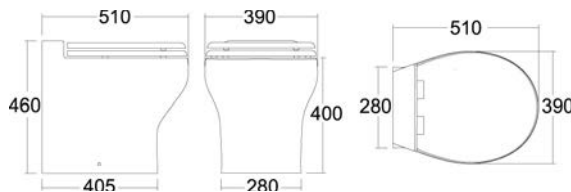

Electro-valve

To be used in toilets that use the fresh water from the onboard system. It also works as an anti-siphon to prevent possible backflow of toilet water into the onboard system.

Code	Version	V	Hose adaptor
50.203.10	Brass	12	1/2"
50.203.11	Brass	24	1/2"
50.203.20 New	Technopolymer	12	14/ 19/ 1/2"
50.203.21 New	Technopolymer	24	14/ 19/ 1/2"



▲ 50.203.20/21



Duralac Green

Renewed version of the original Duralac, it is a plastic insulator and sealant used to prevent galvanic corrosion at the contact point between two different metals, such as: aluminum to rail fixed with stainless steel screws, windlasses in aluminum or brass fixed with stainless steel bolts, stainless steel accessories for the mast fixed on the mast itself (in aluminum) with rivets or screws, cleats secured with different metal studs. Duralac is a yellow, chromate-free, resistant and flexible paste, to be fitted in between the two metals that are jointed together; application with brush; do not dilute.

Code	Package ml
65.750.01	250

OSCULATI



▲ 65.230.01/11



▲ 65.230.03/13



▲ 65.230.02/12



▲ 65.230.02

Accessories for OSCULATI abrasive pastes

Code	Description	To be used with	↔ cm	♻️ PACKAGE
65.230.11 New	2 medium-stiff orange foam pads	65.230.21	Ø 8	20
65.230.12 New	2 medium-soft blue foam pads	65.230.21	Ø 8	20
65.230.13 New	2 soft black bubbly foam pads	65.230.21	Ø 8	20
65.230.01	2 medium-stiff orange foam pads	65.230.22	Ø 15	20
65.230.02	2 medium-soft blue foam pads	65.230.22	Ø 15	20
65.230.03	2 soft black bubbly foam pads	65.230.22	Ø 15	20
65.230.15	Fine wool cover	65.230.24	Ø 18	20
65.230.16	Double-sided rough wool cover	65.230.23	Ø 20	10
65.230.17	Single-sided rough wool cover	65.230.24	Ø 20	10
65.230.21	Backing pad for drill	65.230.11/12/13	Ø 7.5	10
65.230.22	Handheld backing pad	65.230.01/02/03	Ø 15	10
65.230.23	Adapter for rough wool cover	65.230.16	-	10
65.230.24	Backing pad for wool cover	65.230.15/17	Ø 17.5	10
65.230.40	2 microfibre cloths	-	38x38	20



MARLIN Yacht Paints



MARLIN Velox Super antifouling paint

Specific product for submersed metal parts such as propellers, stern drives, shaft lines, etc. It does not degrade with galvanic currents, which are the major cause of paint peeling. Velox Super is the evolution of the well-known Velox Plus and is approved in compliance with BPR directive, also for DIY use (in Italy). The addition of new additives and TEFLON have improved the adhesion properties for better smoothness and easier cleaning.

Code	Colour	Package l
65.886.10BI	<input type="checkbox"/> white	0.5
65.886.10GR	<input type="checkbox"/> Grey	0.5
65.886.10NE	<input type="checkbox"/> black	0.5



MARLIN Yacht Paints



MARLIN Flexy antifouling paint

Flexible antifouling paint suitable for the protection of inflatable boat tubes (neoprene, hypalon, pvc, vinyl leather, etc.).

It can also be applied on fiberglass hard keels. No primer needed on either fabric or fiberglass. Excellent adhesion, effectiveness and flexibility.

Code	Colour	Package l
65.889.01	<input type="checkbox"/> white	0.5
65.889.02	<input type="checkbox"/> Grey	0.5
65.889.03	<input type="checkbox"/> black	0.5





MARLIN Universal Primer

This primer is ideal to isolate old antifouling in bad or unknown conditions before applying a new antifouling paint.
High water resistance and corrosion protection, ideal to isolate iron or wood in mono-component cycles.

Code	Colour	Package l
65.882.01	 Grey	0.75
65.882.02	 Grey	0.5

MARLIN
Yacht Paints
**MARLIN Epogel protective paint**

Epoxy solventless coating resistant to chemicals for interior use.
Ideal to paint bilges as it stops osmosis caused by water absorption from inside the hull.
Certified for food and drinkable water contact, it can be used in refrigerators and drinkable water tanks.

Code	Colour	Package l
65.875.01	 white	0.75
65.875.02	 Grey	0.75
65.875.11	 white	2.5
65.875.12	 Grey	2.5

MARLIN
Yacht Paints
**MARLIN Velox Sil Antifouling paint for propellers and metal parts**

Biocide-free **transparent foul-release** antifouling paint, excellent adhesion, after the application of the special modified **epoxy primer, grey**.
The combination of Primer Sil and Velox Sil ensures exceptional adhesion to metal parts, optimal resistance to galvanic currents, high speeds, and cavitation, without peeling.

Code	Description	The kit contains
65.896.01	250 ml Kit	125 ml grey primer; 125 ml clear varnish
65.896.02	500-ml kit	250 ml grey primer; 250 ml clear paint
65.896.03	1000 ml Kit	500 ml grey primer; 500 ml clear varnish

MARLIN
Yacht Paints
**MARLIN Light Sil antifouling paint for underwater lights**

transparent foul-release biocide-free antifouling paint. Strong adhesion on glass and metal.
Total transparency not to affect the light output.
Any growth of vegetation will be removed with the movement of the boat or with a light cleaning using a sponge.
All kits include a small brush for application.

Code	Description
65.897.01	70 ml Kit
65.897.02	250 ml Kit

MARLIN
Yacht Paints
**MARLIN Eco Sil antifouling paint for echo sounder transducers**

Biocide-free **transparent foul-release** antifouling paint. It provides strong adhesion on plastic, does not interfere with the echosounder signal.
The solvents in the paint do not attack either the plastic or the seals.
Any vegetation growth will be removed by the motion of the boat or through light cleaning using a sponge.
A small brush for application is included.

Code	Description
65.898.01	70 ml Kit

MARLIN
Yacht Paints



Compact radio-controlled weather station

Facts supplied:

- Radio-controlled time and date;
- Lunar phases, calendar, alarm;
- Inside/outside temperature and inside/outside humidity with trends + minimum and maximum memory;
- Barometric pressure expressed in hPa/mb/inHg;
- Weather forecasts with alert;
- Frost warnings;
- Adjustable backlight;
- Wall mounting or table stand;
- Power supply: 2 AA batteries (LR6), 2 AAA batteries (LR3), AC/DC adapter (included)

Code	↔ mm
28.883.52	148x85x44.4



Professional wireless weather station

Facts supplied:

- Time and date + calendar;
- Weather forecast with 6 icons;
- Barometric pressure from 800 mb to 1100 hPa;
- Inside/outside temperature with trend indication and minimum/maximum memory;
- Indoor/Outdoor humidity with minimum/maximum memory;
- Rain gauge from 0 to 999 mm with history and memory;
- Anemometer: 0-178 km (mph or km) max speed and history last hour, 24h, week, month, year + wind direction;
- Automatic or adjustable backlight;
- PC connection via WiFi with the App "La Crosse View";
- Power supply: 1 CR2032 battery included + AC/DC adapter included, 2 AAA batteries (LR3) + 4 AA batteries (LR6) + 2 batteries (LR14).

Code	↔ mm
28.918.04	208x148x30



SCOUT KS-42 VHF Antenna

Code 29.997.00

Antenna in **ice white fiberglass** with UV filter, filled with **waterproof polyurethane**, high strength, 1.5 mm thickness. Length 2.40 m, standard attachment 1" x 14 threads in chrome-plated brass. **Gain 3 dB** and maximum input power 50 W. Complete with 5-m of RG-58 cable and PL-259 connector. Ideal for medium and large boats.



SCOUT KS-7B fiberglass CB Antenna

Code 29.910.00

Body in **ice white fiberglass** with UV filter, 1.4 mm thick, entirely filled with **waterproof polyurethane**. Complete with 5-m of RG-58 coaxial cable and PL-259 connector. Length 1.5 m, standard attachment 1" x 14 threads. Maximum input power 10 W.

SCANSTRUT aluminium Power Tower 150 mm for Starlink

Designed to install Starlink antennas on the roof, T-top, flybridge, or boat radar arch. This Power Tower ensures obstacle removal and positions your Starlink at an ideal angle of 8° for optimal connectivity. Designed for the marine environment, it is custom-made to fit Starlink High-Performance systems. Pre-drilled mounting holes allow for secure attachment directly to the tower. The integrated Scanstrut cable seal ensures watertight installation. No need to remove Starlink connectors during installation. Finishing complies with the exclusive marine paint system. Made of premium quality aluminum suitable for the marine environment.

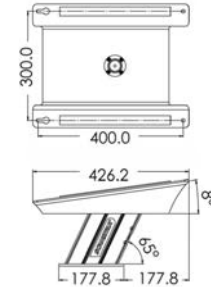

Code	Colour
29.902.10	white

OSCULATI special brush

Polyurethane-coated marine wood structure, shock-proof rim, premium fibres, anodized aluminium snap coupling. 2 sizes available: 8" and 10".



8" Brush 195 (a) x 85 (b) mm	10" Brush 250 (a) x 90 (b) mm	Fibres	
		Type	material
36.633.01 New	36.634.01 New	extra soft	Green Polyester
36.633.03	36.634.03	soft	Yellow polyester
36.633.05	36.634.05	Medium hardness	Blue polyester

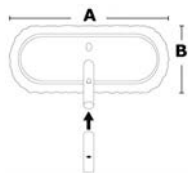

OSCULATI mop with very high water absorption

With snap coupling, made of anodized aluminium.



Code	Description
36.638.01	Classic in PVA synthetic leather
36.638.02 New	Extra absorbent with 7.5 cm wide strips

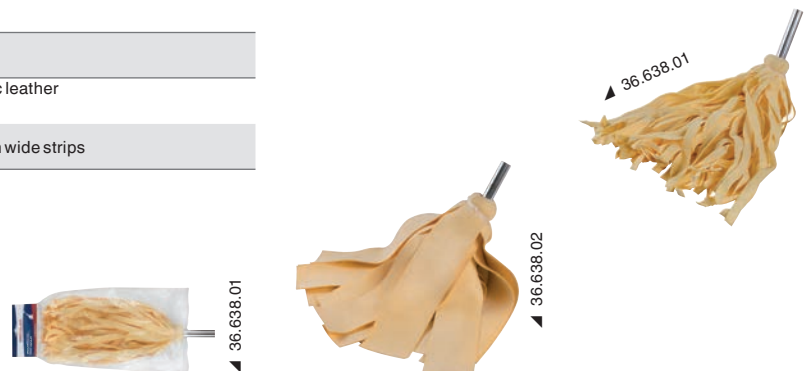



▲ 52.330.xx

VERSIONS FOR INCH SHAFTS



▲ 52.331.xx

Rubber stuffing box

Long lasting insulation from water seepage, low maintenance required if correctly treated. Made of a special type of rubber resistant to salt water and lubricating grease. The product is supplied with an AISI316 stainless steel clamp and specific lubricant for shaft line. Operation of the stuffing box is usually under the waterline; lubrication and cooling by water. In case of operation above or on the waterline, an external water cooling source is needed.

Version A: brass hose adaptor for external lubrication by water (if not used, a brass closing cap is supplied) + greasing aperture with brass cap.
Version B: no hose adaptor and greasing aperture.

The kit includes: stuffing box + specific lubricant tube + instructions.

Version		Centerline Ø mm	Stuffing box case Ø mm
A	B		
52.330.26	52.331.26	25.4 (1")	44
52.330.31	52.331.31	31.8 (1" 1/4)	52
52.330.36	52.331.36	38.1 (1" 1/2)	58
52.330.41	52.331.41	44.5 (1" 3/4)	64
52.330.46	52.331.46	50.8 (2")	70



▲ 52.193.00



▲ 52.193.00



▲ 52.193.01



▲ 52.193.02



▲ 52.193.03

YACHTICON Aqua Clean for fresh water tanks

For processing and storage of fresh water in tanks. It prevents contamination for up to 6 months. Silver-based, **free from chlorine** or other chemicals, this tasteless and odourless product **can be used in both drinking and non-drinking water**. Contained in flexible or rigid tanks (in case of aluminium tanks, use liquid version 52.193.00).

Code	Description	Package	For litres
52.193.00	Small ready-to-use bottles	100 ml	1.000
52.193.01	Powder package (dispenser included)	100 g	10.000
52.193.02	Tabs	100 pcs	500
52.193.03 New	Tabs	100 pcs	2000

With the purchase of 16 pcs, you'll receive a complimentary display stand

Leather and neoprene covers

UV-resistant leather spreader boots. An elastic rim at the edges allows perfect fit regardless of the shape of the spreaders. Inside neoprene lining for optimal fit. Leather coating on the outside ensures a soft surface for sail protection. Provided with velcro for secure fastening. Suitable to wide spreader arms. Sold in pairs and available in 4 sizes.

Code	Crosstree section mm	
	Continuous rig	Linked rig
57.491.01	55-95	-
57.491.02	95-122	74-95
57.491.03	-	105-122
57.491.04	-	122-154

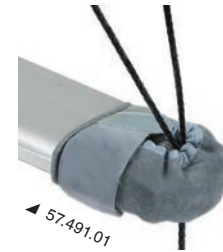

Self-adhesive patches for repairing laminated regatta sails

Made of ultra-resistant transparent film normally used to manufacture laminated sails.



Code	↔ cm	The kit contains	Colour
10.391.00	24 x 37	8 pieces	transparent



Intercooler ring plus gasket

For Volvo engines.

Code	Original reference	Product	Motor
43.932.30	858979	Seal ring	AD31/AD41D/TAMD 41B
43.932.31	860920/838720	Seal	AD31/AD41D/KAD 44P

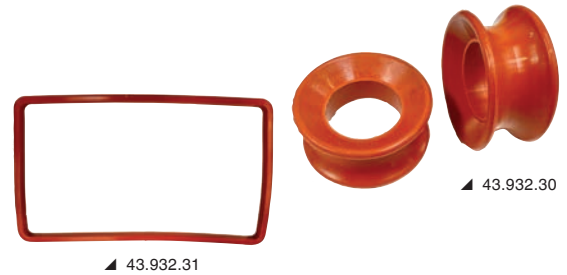

End stop buffer

For Volvo engines.
For stern legs.

Code	Original reference	Leg
43.932.33	854133/852772	290/290A/DP290A/290SP/290DP



Non-return valve (discharge flap)

For Volvo engines.

Code	Original reference	Leg
43.957.00	872438	DP-D/DP-D1/DP-E
43.957.01	852644	280/280DP - 290/290DP



OCEANSOUTH



▲ 19.348.01/08



▲ 19.349.01/08

Lewmar Flush manhole covers

Made from ATLAS fabric 310g/m², waterproof, breathable and UV resistant.

blue	grey	Size	Style manhole	↔ outside mm	
				x	Y
19.348.01	19.349.01	10	Square	330	330
19.348.02	19.349.02	20	Rectangular	417	272
19.348.05	19.349.05	44	Square	512	512
19.348.07	19.349.07	60	Square	577	577
19.348.08	19.349.08	70	Square	697	697

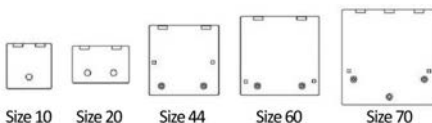

OCEANSOUTH



▲ 19.346.02/11



▲ 19.347.02/11

Lewmar Low profile hatch covers

Made from ATLAS fabric 310g/m², waterproof, breathable and UV resistant

blue	grey	Size	Style manhole	↔ outside mm		Ø mm
				x	Y	
19.346.02	19.347.02	3	Rectangular	301	246	-
19.346.03	19.347.03	10	Square	330	330	-
19.346.04	19.347.04	20	Rectangular	417	272	-
19.346.05	19.347.05	30	Rectangular	527	397	-
19.346.06	19.347.06	40	Square	491	491	-
19.346.07	19.347.07	41	Rectangular	491	246	-
19.346.08	19.347.08	44	Square	512	512	-
19.346.10	19.347.10	54	Rectangular	577	462	-
19.346.11	19.347.11	60	Square	577	577	-
19.346.12	19.347.12	70	Square	698	698	-
19.346.15	-	18	circular	-	-	490
19.346.16	-	22	circular	-	-	588



OCEANSOUTH



▲ 52.958.01/05



▲ 52.958.06

Oceansouth Propeller Protection

Made of high-resistance, UV-resistant polyester.
 Padded with 6-mm polyurethane foam, reinforced seams and snap button fastening.
 Sturdy handle and non-slip interior to ensure ease and stability during transport.
 High-visibility color for increased safety during towing.

Code	Ø mm
52.958.01	200
52.958.02	260
52.958.03	320
52.958.04	360
52.958.05	410
52.958.06	435 (double/twin)

Oceansouth T-Top extension

Extension kit designed to expand the shaded area.
 To be installed universally on any T-Top equipped with at least 2 rod holders
 220gr/m² fabric in ATLAS waterproof and UV-resistant polyester; stainless steel telescopic tubes.
 No tools or drilling required for installation; easily removable for storage after use.

white	black	A cm	B cm
46.910.01	46.910.02	137	121
46.910.04	46.910.05	182	152

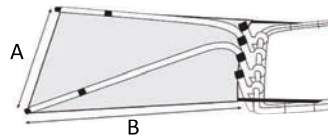

OCEANSOUTH



▲ 46.910.01/04



▲ 46.910.02/05



Front extension bimini top for T-tops

Made of ATLAS™ fabric, waterproof, UV resistant and breathable, 220 gr/m².
 Ideal to protect the cushions from the sun.

Blu navy	black		A cm	B cm
48.198.01	48.198.11	New	200	275
48.198.03	48.198.13	New	245	290
48.198.04	48.198.14	New	275	305

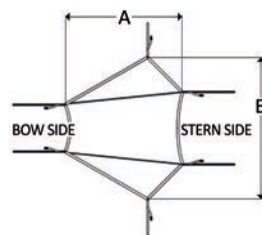

OCEANSOUTH



Rudder wheel covers for sailing boats

Made of durable, breathable ATLAS 310 g/m² fabric that reduces condensation and provides excellent UV protection.

navy blue	Diameter Ø mm
46.183.01	610
46.183.02	812
46.183.03	915
46.183.04	1015
46.183.05	1115
46.183.06	1215
46.183.07	1315
46.183.08	1415
46.183.09	1515
46.183.10	1615

OCEANSOUTH



OCEANSOUTH

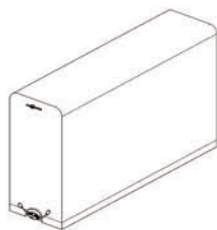

Covers for sailing boat cockpit tables

Made of durable, breathable ATLAS 310 g/m² fabric that reduces condensation and provides excellent UV protection.

navy blue	Length cm	Width cm	Height cm
46.182.01	95	30	65
46.182.02	105	40	65
46.182.03	120	35	65
46.182.05	135	50	70
46.182.06	145	55	70



OCEANSOUTH

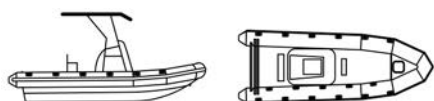

Rib Boat

Tailored tarpaulin for inflatables with T-Top and central guide

Made of ATLAS 280 g/m² waterproof, breathable and UV resistant fabric. Double stitching for increased durability

Code	Dinghy size		←→ tarpaulin		Colour
	Length cm	Width cm	Length cm	Width cm	
46.165.21	720/750	280	950	660	grey
46.165.22	760/790	280	980	660	grey
46.165.23	800/830	280	1020	660	grey
46.165.24	840/870	310	1060	670	grey
46.165.25	880/910	310	970	610	grey
46.165.26	920/950	320	1020	630	grey
46.165.27	960/990	320	1060	630	grey
46.165.28	1000/1050	320	1110	630	grey
46.165.29	1060/1100	320	1160	630	grey

OCEANSOUTH



Tarpaulin for cabin runabouts with inboard engine

Made of ATLAS fabric 280g/m², waterproof, breathable and UV resistant. Double stitching for increased durability.

Code	Boat size		←→ tarpaulin		Colour
	Length cm	max width cm	Length cm	Width cm	
46.171.10	670/720	270	940	490	grey
46.171.11	720/780	270	1000	490	grey
46.171.12	780/840	290	1060	500	grey
46.171.13	840/900	310	1120	520	grey
46.171.14	900/960	310	1180	530	grey
46.171.15	960/1020	310	1240	540	grey



OCEANSOUTH



Tailored tarpaulin for open hulls with T-TOP

Made of ATLAS fabric 240g/m², waterproof, breathable and UV resistant. Double stitching for increased strength.

Recommended for trailer towing at low speed, max 60 km/h. Whether purchased for a double-engine boat, buy a larger size.

Code	Boat size		Colour
	Length cm	max width cm	
46.171.46	720/750	260	grey
46.171.47	750/780	260	grey
46.171.48	780/810	300	grey
46.171.49	810/840	300	grey
46.171.50	840/870	300	grey
46.171.51	870/900	300	grey
46.171.52	900/930	300	grey
46.171.53	930/960	300	grey
46.171.54	960/990	300	grey
46.171.55	990/1020	300	grey



Tailored cover for Mercury engines

Specifically shaped for the engine model, suitable for open area storage. Made of ATLAS 340g/m² waterproof, breathable and UV-resistant fabric.

For engine head Ventilated – can also be used during navigation	Colour	Motor	HP	Year
46.540.38	<input type="checkbox"/> white	V12 7.6L	600	2021>
46.540.37	<input checked="" type="checkbox"/> black	V10 5.7L	400	2023>
46.540.39	<input type="checkbox"/> white	V10 5.7L	400	2023>
46.540.40	<input type="checkbox"/> white	V8 4.6L	250/450	2018>
46.540.41	<input type="checkbox"/> white	V6 3.4L	175/225	2018>



OCEANSOUTH



Tailored cover for Yamaha engines

Specifically shaped for the engine model, suitable for outdoor storage. Made of ATLAS fabric 340g/m², waterproof, breathable, and UV resistant.

For engine head Ventilated – can also be used during navigation	Colour	Motor	HP	Year
46.541.54	<input type="checkbox"/> white	V6 4.2L e 4.3L	F225/250/300 & F350 (2024)	2021>
46.541.24	<input checked="" type="checkbox"/> grey	4-cylinder 4T 2.8L	F150D/F175A/F200F	2023>
46.541.55	<input type="checkbox"/> white	4-cylinder 4T 2.8L	F150D/F175A/F200F	2023>



OCEANSOUTH



Tailored cover for Honda engines

Specifically shaped for the engine model, suitable for outdoor storage. Made of ATLAS fabric 340g/m², waterproof, breathable, and UV resistant.

Ventilated – can also be used during navigation	Colour	Motor	HP	Year
46.544.10	<input checked="" type="checkbox"/> grey	BF350 V8 4.9L	350	2024>
46.544.32	<input type="checkbox"/> white	BF350 V8 4.9L	350	2024>
46.544.31	<input type="checkbox"/> white	BF175/200/225/250 V6 3.6L	175/250	2019>



OCEANSOUTH



Tailored cover for Suzuki engines

Specifically shaped for the engine model, suitable for outdoor storage. Made of ATLAS fabric 340g/m², waterproof, breathable, and UV resistant.

For engine head Ventilated – can also be used during navigation	Colour	Motor	HP	Year
46.542.40	<input type="checkbox"/> white	V6 4T 4-4L	DF325/350	2017>
46.542.41	<input type="checkbox"/> white	V6 4T 4L	DF250AP/300AP	2012>
46.542.42	<input type="checkbox"/> white	4-cylinder 4T 2L	DF115BG/140BG	2021>



OCEANSOUTH



OCEANSOUTH

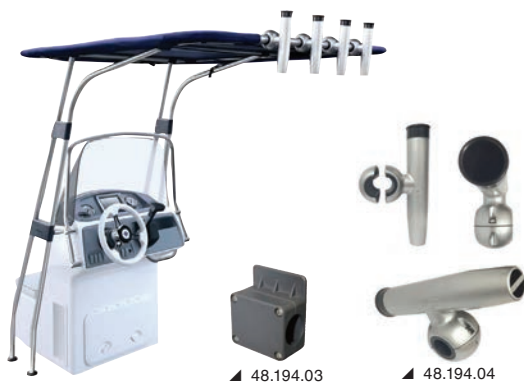

Anodized aluminum T-Top

Made of anodized tube Ø 32 mm. Universal, as connections can be adjusted at will. T-Top made of blue, waterproof and UV-resistant ATLAS polyester fabric. All stainless steel components.

Code	Tube Ø mm	Length A mm	Width B mm	Max width of console A1 mm	Max height C mm	Colour
48.194.11	32	1700	1200	1000	2010	blue
48.194.12	32	1700	1400	1000	2010	blue

- 48.194.04 Fishing rod holder for 32-mm Ø tube
- 48.194.03 Supports for navigation lights.

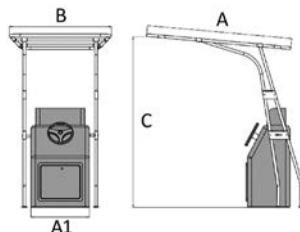

OCEANSOUTH



Professional aluminium T-top

Made from Ø 44-mm tubes, complete with high-strength resin fittings and high-quality welded parts. Universal as the console attachments can be adjusted at will. T-Top made of waterproof and UV-resistant ATLAS polyester fabric.

Epoxy powder-coated frame.

Code	Tube Ø mm	Length A mm	Width B mm	Max width of console A1 mm	Max height C mm	Colour	Fabric colour
48.195.04	44	2000	1400	900	2050	white	blue
48.195.44	44	2000	1400	900	2050	black	black
48.195.05	44	2000	1600	1000	2050	white	blue
48.195.55	44	2000	1600	1000	2050	black	black

- 48.195.01 Nylon rod holder for 44-mm Ø pole.
- 48.195.02 Supports for navigation lights.

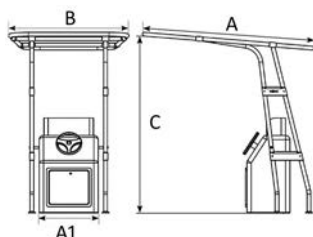

OCEANSOUTH



Professional Heavy Duty T-Top in painted aluminium

Made of 44-mm Ø tube with high-resistance resin connections and top-quality welded parts. Universal for any type of console since the connections are adjustable. The T-Top fabric is made of waterproof and UV-resistant blue Atlas polyester.

Epoxy powder coated frame

Code	Tube Ø mm	A mm	B mm	Max width of console A1 mm	Max height C mm	Colour	Fabric colour
48.193.01	44	1400	2000	900	2050	white	blue
48.193.02	44	1400	2000	900	2050	black	black

- 48.195.01 Nylon rod holder for 44-mm Ø pipe.
- 48.195.02 Navigation light support.

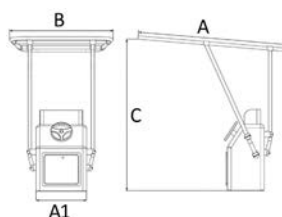

Sirocco ergonomic seat

Foldable seat with lock.
 HD foam core. UV-resistant upholstery.
 Lower fastening bores with standard centre distance.

Code		Upholstery colour
48.407.01		white
48.407.02	New	Grey/white
48.407.03	New	White/Blue
48.407.04		Light grey + dark grey

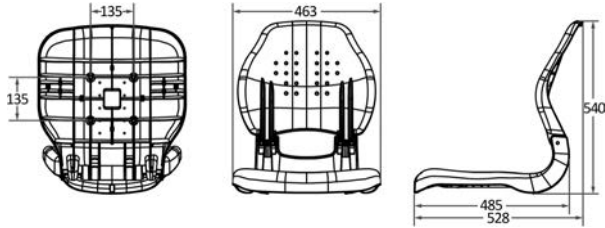

OCEANSOUTH



Waverider seat support with shock absorber, swivel head and recessed aluminium base

Adjustable height through gas spring. Fitted with internal **shock absorber** to absorb the boat impact against the waves.
 Removable from the Ø 228-mm **anodized aluminum** base . Anodized aluminum tubes. Nylon/ fiberglass head with universal drilling.

Code	Height mm	Type	Pedestal Ø mm	Additional snap-in base
48.707.40	310/390	Telescopic	75/65	48.707.43
48.707.41	440/570	Telescopic	75/65	48.707.43
48.707.42	520/650	Telescopic	75/65	48.707.43

OCEANSOUTH

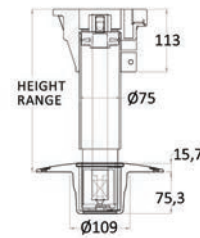
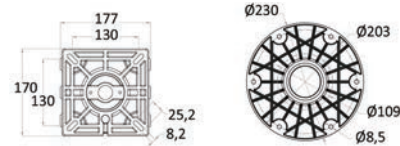
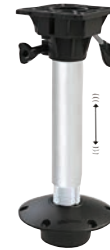



OSCULATI GADGET and CLOTHING line

Promotional items will be sent by our sales department upon request. Please state the code of the item you wish to receive.

CLASSIC T-SHIRT



70.190.08-21MB

Crew neck short sleeve T-shirt.
Colour: blue.
Fabric: 100% cotton, 160 g.
Model: Unisex.
Available sizes: XS, S, M, L, XL, XXL, XXXL.

CLASSIC POLO SHIRT



70.190.01-21MB

Short sleeve two button polo shirt, side slits. Ribbed collar and sleeves. Colour: blue with white inserts. Fabric: 100% cotton piquet, 190 g. Model: Unisex.
Available sizes: XS, S, M, L, XL, XXL, XXXL.

SHOPPING BAG



70.199.15-01

Reusable shopping bag made of H.D. 02 white, fold-over die cut bag. 70 My. Dimensions: Ø 35x55x20 cm.

SHOPPING BAG WITH SHOULDER STRAP



70.199.21

Non-woven fabric shopping bag, 120 g., additional matt lamination and cardboard bottom. Dimensions: 37x30x0.8 cm + shoulder strap 115x8 cm.

SPORT BLUE POLO SHIRT



MAN: 70.190.01-21MR

WOMAN: 70.190.01-21WR

Short sleeve two button polo shirt, side slits. Red band under the collar. Ribbed collar and sleeves. Fabric: 100% cotton piquet, 190 g. Colour: blue with red inserts. Available sizes: MAN XS, S, M, L, XL, XXL, XXXL.
Available sizes: WOMAN XS, S, M, L, XL, XXL.

SPORT WHITE POLO SHIRT



MAN: 70.190.01-21MW

WOMAN: 70.190.01-21WW

Short sleeve two button polo shirt, side slits. Ribbed collar and sleeves. Fabric: 100% cotton piquet, 190 g. Colour: white with blue inserts. Available sizes: MAN XS, S, M, L, XL, XXL, XXXL.
Available sizes: WOMAN XS, S, M, L, XL.

THERMAL CUP/ WATER BOTTLE

#BLUEPLANET



70.199.26-21MR

Made of SS, anti-slip rubber finishing. Keeps temperature up to 90 min. Colour: red. Capacity: 450 ml.

BADGE LANYARDS

70.199.20

Neck badge satin lanyard with standard shackle. Colour: red. Dimensions: 2x47 cm.



KEYRING

70.199.16-210

Floating keyring. Material: EVA 12 mm + central support in white PVC. White lanyard with 3 cylinders (blue, white, red) in EVA + metal ring Measures: 6x10 cm.



CLASSIC SWEATSHIRT



70.190.11-21MB

Full zip two pocket sweatshirt. Ribbed hem and cuffs. Colour: blue with white inserts. Fabric: 70% cotton 30% polyester, 330 g. Model: Unisex.
Available sizes: XS,S,M,L,XL,XXL,XXXL.

CLASSIC SOFTSHELL



70.199.40

Three pocket softshell. Colour: blue with white and red inserts. Fabric: 310 g. Model: Unisex.
Available sizes: XS,S,M,L,XL,XXL,XXXL.

FLAG

Print with perimeter stitching and two laces on the two corners. Material: 115 gr windproof nautical cloth.

70.199.23: Rectangular (100x150)

70.199.23-04: Rectangular (220x150)

Sublimatic printing, complete with rod, round steel base and bag. Outdoors and indoors. Material: Windproof nautical towel 110 gr.

70.199.23-01

Small drop (95,7x216,5 cm)

70.199.23-02

Large drop (122,9x301,3 cm)

70.199.23-03

Large sail (91,2x346 cm)



CLASSIC CAP



70.190.04-21B

Cap with DRY-TECH inner lining, suitable for outdoor sports. Pre-curved brim and embroidered eyelets. Closure: velcro and PVC strip. Colour: blue. Fabric: UPF50+, 75% nylon, 20% cotton, 5% elastam Model: Unisex. One size fits all

SPORT CAP



70.190.04-21W

Cap with pre-curved brim, embroidered eyelets and eyelet for lanyard attachment. Closure: velcro. Colour: white with blue and red inserts. Fabric: 100% cotton. Model: Unisex. One size fits all

STICKERS



70.199.12-01 (20x16 cm) 2 pc

70.199.12-02 (40x4,2 cm) 2 pc

70.199.19 (corner 45x42 cm) 1 pc

PVC sticker with Osculati logo.

BALL PEN



70.199.25-21BR

Metal ball point with blue or red refill and touch pen tip. Sold in the two colours depending on availability. Dimensions: Ø 8x142 mm.



OSCULATI
Since 1958



www.OSCULATI.com

Osculati S.r.l.
Via Pacinotti 12
20054 Segrate (Milano) - Italy
info@osculati.it

Reference 70.199.05EN



8 033137 029967



IT AEO-F 23 2010

